

**200-125.examcollection.premium.exam.62q**

Number: 200-125  
Passing Score: 800  
Time Limit: 120 min  
File Version: 1.0



**200-125**

**Cisco Certified Network Associate Exam**

**Version 1.0**



**Exam A****QUESTION 1**

A network administrator needs to configure port security on a switch. Which two statements are true? (Choose two.)

- A. The network administrator can apply port security to dynamic access ports.
- B. The network administrator can apply port security to EtherChannels.
- C. The sticky learning feature allows the addition of dynamically learned addresses to the running configuration.
- D. When dynamic MAC address learning is enabled on an interface, the switch can learn new addresses, up to the maximum defined.
- E. The network administrator can configure static secure or sticky secure MAC addresses in the voice VLAN.

**Correct Answer:** CD

**Section:** (none)

**Explanation**

**Explanation/Reference:**

Explanation:

**QUESTION 2**

Which interface counter can you use to diagnose a duplex mismatch problem?

- A. no carrier
- B. late collisions
- C. giants
- D. CRC errors
- E. deferred
- F. runts

**Correct Answer:** B

**Section:** (none)

**Explanation**

**Explanation/Reference:**

Explanation:

**QUESTION 3**

Which switching method duplicates the first six bytes of a frame before making a switching decision?

- A. fragment-free switching
- B. store-and-forward switching

- C. cut-through switching
- D. ASIC switching

**Correct Answer:** C  
**Section:** (none)  
**Explanation**

**Explanation/Reference:**  
Explanation:

#### QUESTION 4

Which logging command can enable administrators to correlate syslog messages with millisecond precision?

- A. no logging console
- B. logging buffered 4
- C. no logging monitor
- D. service timestamps log datetime msec
- E. logging host 10.2.0.21

**Correct Answer:** D  
**Section:** (none)  
**Explanation**



**Explanation/Reference:**  
Explanation:

#### QUESTION 5

Which two spanning-tree port states does RSTP combine to allow faster convergence? (Choose two.)

- A. blocking
- B. learning
- C. forwarding
- D. discarding
- E. listening

**Correct Answer:** AE  
**Section:** (none)  
**Explanation**

**Explanation/Reference:**

Explanation:

**QUESTION 6**

Which feature can you implement to reserve bandwidth for VoIP calls across the call path?

- A. PQ
- B. CBWFQ
- C. round robin
- D. RSVP

**Correct Answer:** D

**Section:** (none)

**Explanation**

**Explanation/Reference:**

Explanation:

**QUESTION 7**

Which three statements about link-state routing are true? (Choose three.)

- A. OSPF is a link-state protocol.
- B. Updates are sent to a broadcast address.
- C. It uses split horizon.
- D. Routes are updated when a change in topology occurs.
- E. RIP is a link-state protocol.
- F. Updates are sent to a multicast address by default.



**Correct Answer:** ADF

**Section:** (none)

**Explanation**

**Explanation/Reference:**

Explanation:

**QUESTION 8**

Which command can you enter to determine whether a switch is operating in trunking mode?

- A. show ip interface brief
- B. show vlan
- C. show interfaces

D. show interface switchport

**Correct Answer:** D

**Section:** (none)

**Explanation**

**Explanation/Reference:**

Explanation:

### QUESTION 9

What are three benefits of implementing VLANs? (Choose three.)

- A. A higher level of network security can be reached by separating sensitive data traffic from other network traffic.
- B. A more efficient use of bandwidth can be achieved allowing many physical groups to use the same network infrastructure.
- C. A more efficient use of bandwidth can be achieved allowing many logical networks to use the same network infrastructure.
- D. Broadcast storms can be mitigated by decreasing the number of broadcast domains, thus increasing their size.
- E. Port-based VLANs increase switch-port use efficiency, thanks to 802.1Q trunks.
- F. VLANs make it easier for IT staff to configure new logical groups, because the VLANs all belong to the same broadcast domain.
- G. Broadcast storms can be mitigated by increasing the number of broadcast domains, thus reducing their size.

**Correct Answer:** ACG

**Section:** (none)

**Explanation**

**Explanation/Reference:**

Explanation:

### QUESTION 10

Which command can you enter to view the ports that are assigned to VLAN 20?

- A. Switch#show ip interface vlan 20
- B. Switch#show vlan id 20
- C. Switch#show ip interface brief
- D. Switch#show interface vlan 20

**Correct Answer:** B

**Section:** (none)

**Explanation**

**Explanation/Reference:**

Explanation:

#### QUESTION 11

In which two formats can the IPv6 address fd15:0db8:0000:0000:0700:0003:400F:572B be written? (Choose two.)

- A. fd15:0db8:0000:0000:700:3:400F:527B
- B. fd15::db8::700:3:400F:527B
- C. fd15:db8:0::700:3:4F:527B
- D. fd15:0db8::7:3:4F:527B
- E. fd15:db8::700:3:400F:572B

**Correct Answer:** AE

**Section:** (none)

**Explanation**

**Explanation/Reference:**

Explanation:

#### QUESTION 12

When an interface is configured with PortFast BPDU guard, how does the interface respond when it receives a BPDU?

- A. It continues operating normally.
- B. It goes into a down/down state.
- C. It becomes the root bridge for the configured VLAN.
- D. It goes into an errdisable state.

**Correct Answer:** D

**Section:** (none)

**Explanation**

**Explanation/Reference:**

Explanation:

#### QUESTION 13

What are three characteristics of the TCP protocol? (Choose three.)

- A. It uses a single SYN-ACK message to establish a connection.
- B. The connection is established before data is transmitted.
- C. It ensures that all data is transmitted and received by the remote device.
- D. It supports significantly higher transmission speeds than UDP.

- E. It requires applications to determine when data packets must be retransmitted.
- F. It uses separate SYN and ACK messages to establish a connection.

**Correct Answer:** BCF

**Section:** (none)

**Explanation**

**Explanation/Reference:**

Explanation:

#### **QUESTION 14**

Scenario

Refer to the topology. Your company has decided to connect the main office with three other remote branch offices using point-to-point serial links.

You are required to troubleshoot and resolve OSPF neighbor adjacency issues between the main office and the routers located in the remote branch offices.

Use appropriate show commands to troubleshoot the issues and answer all four questions.

Instructions



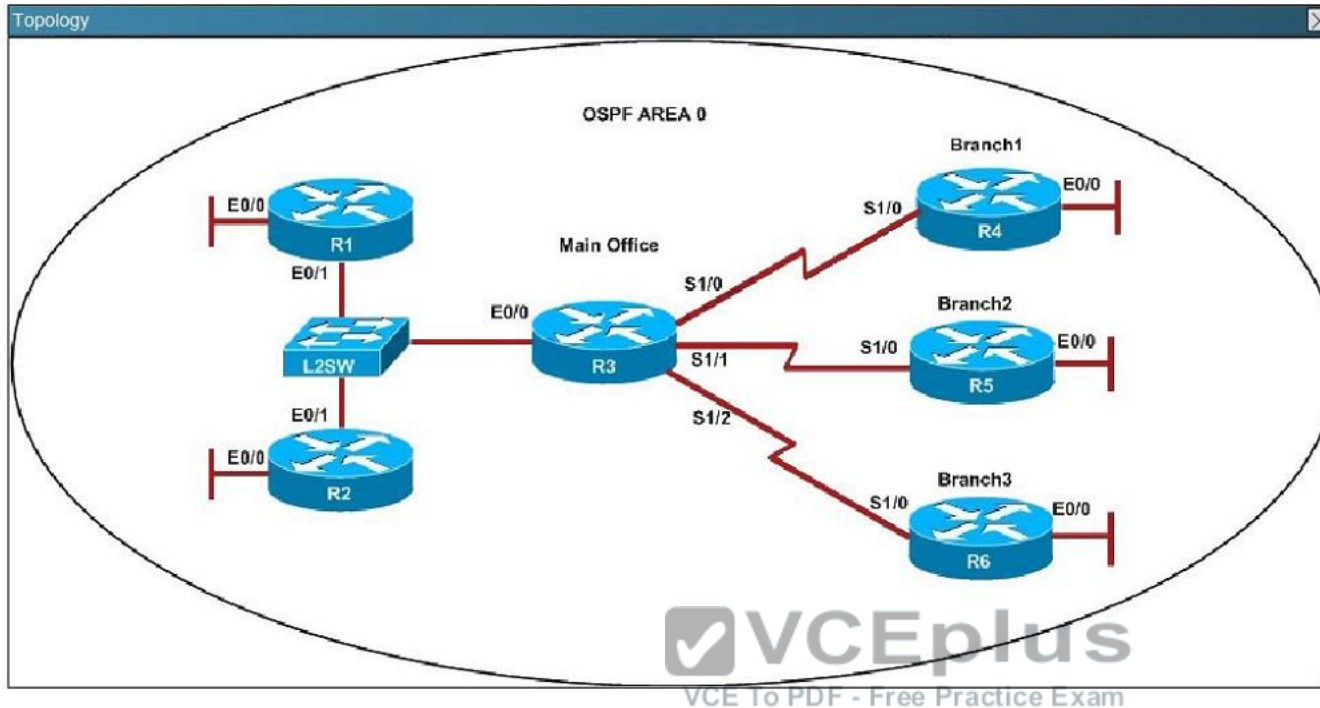



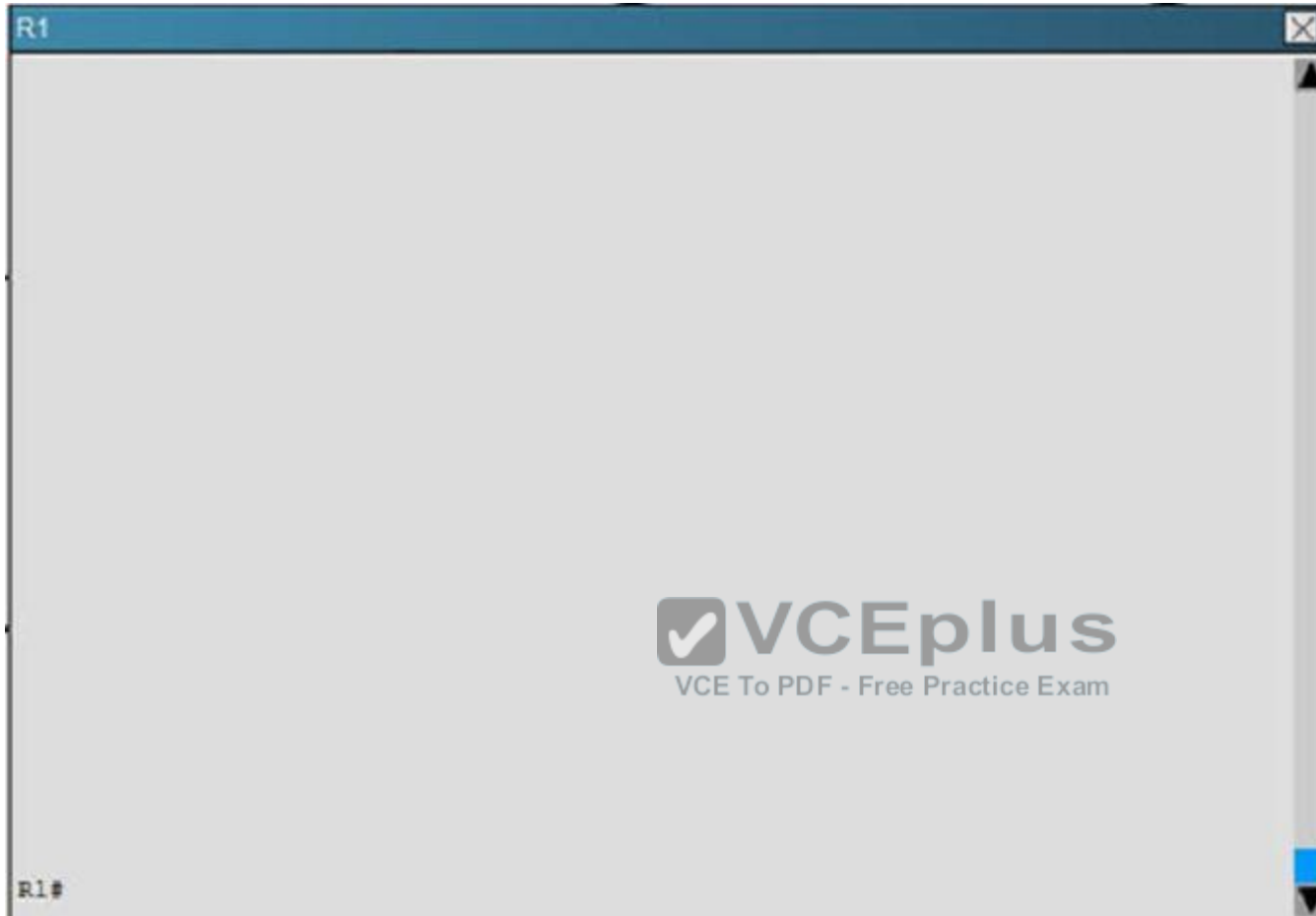

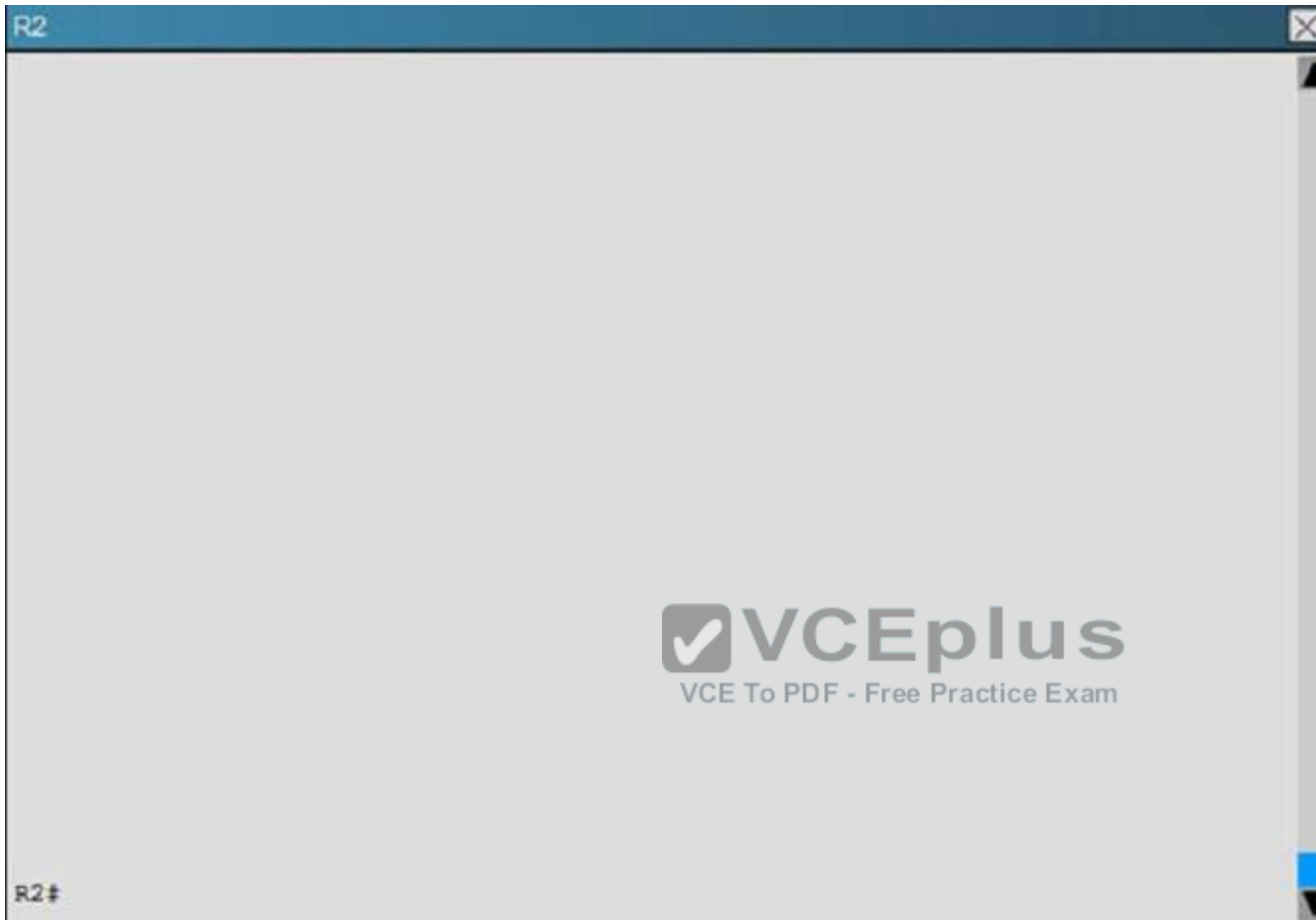

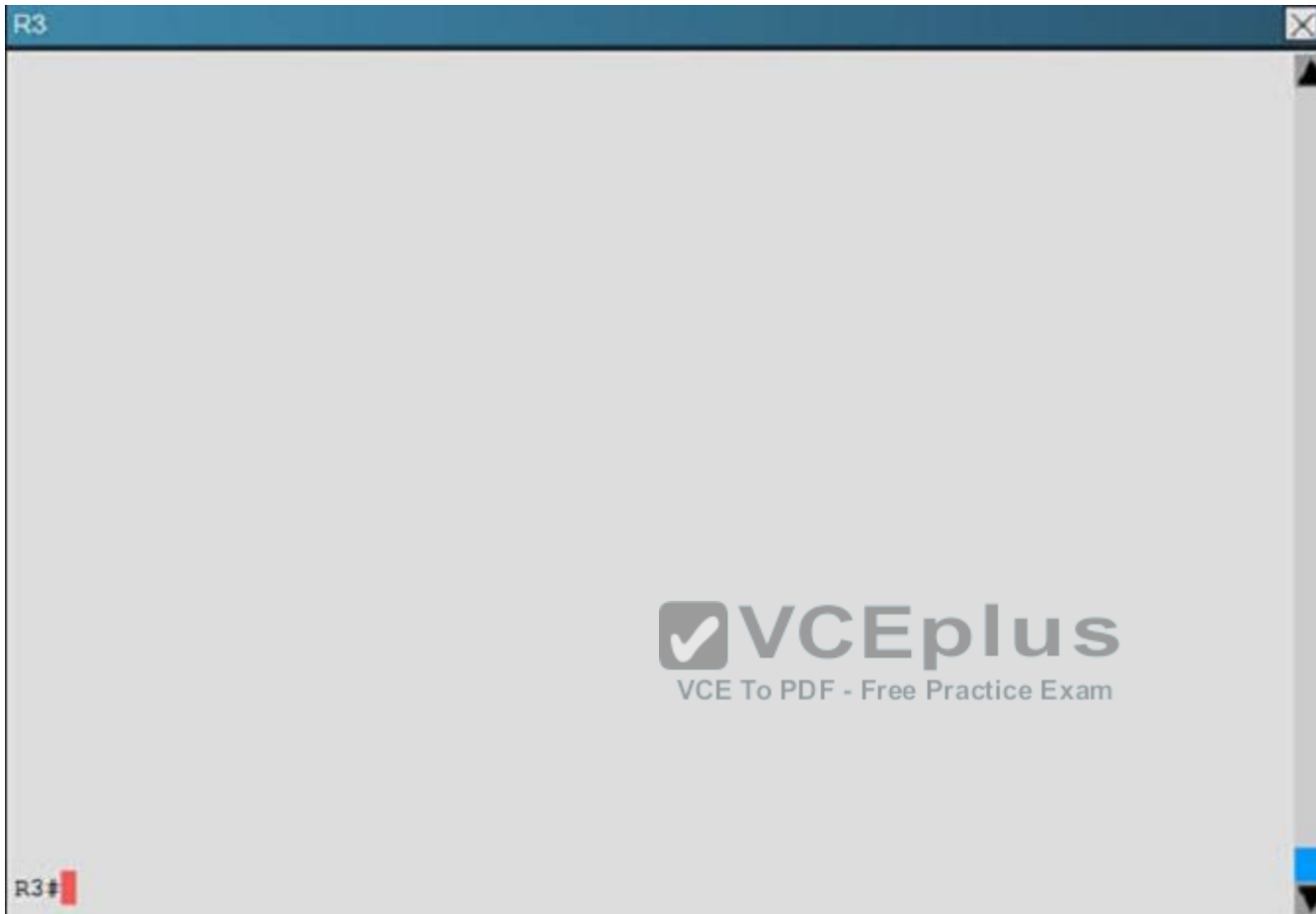

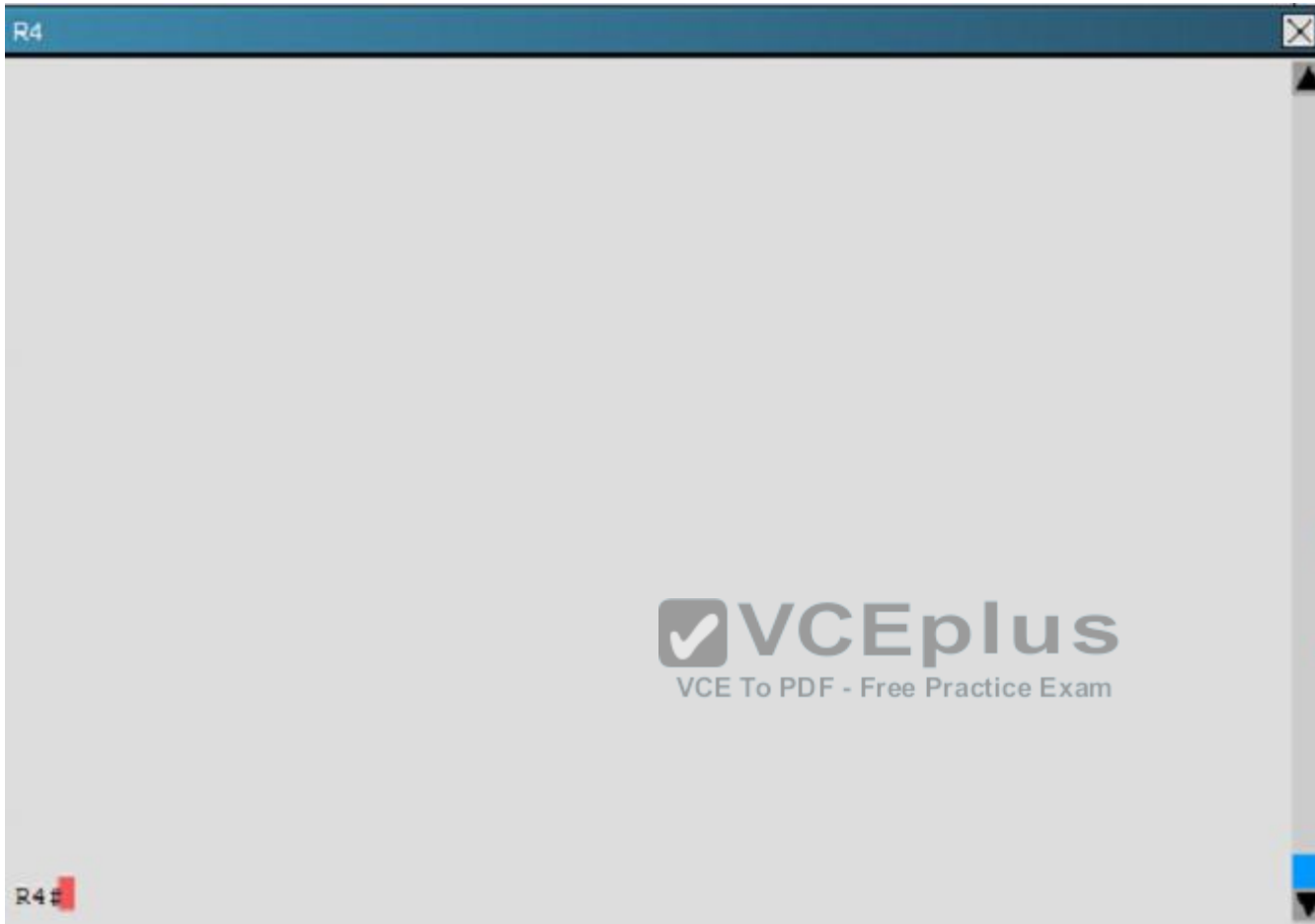

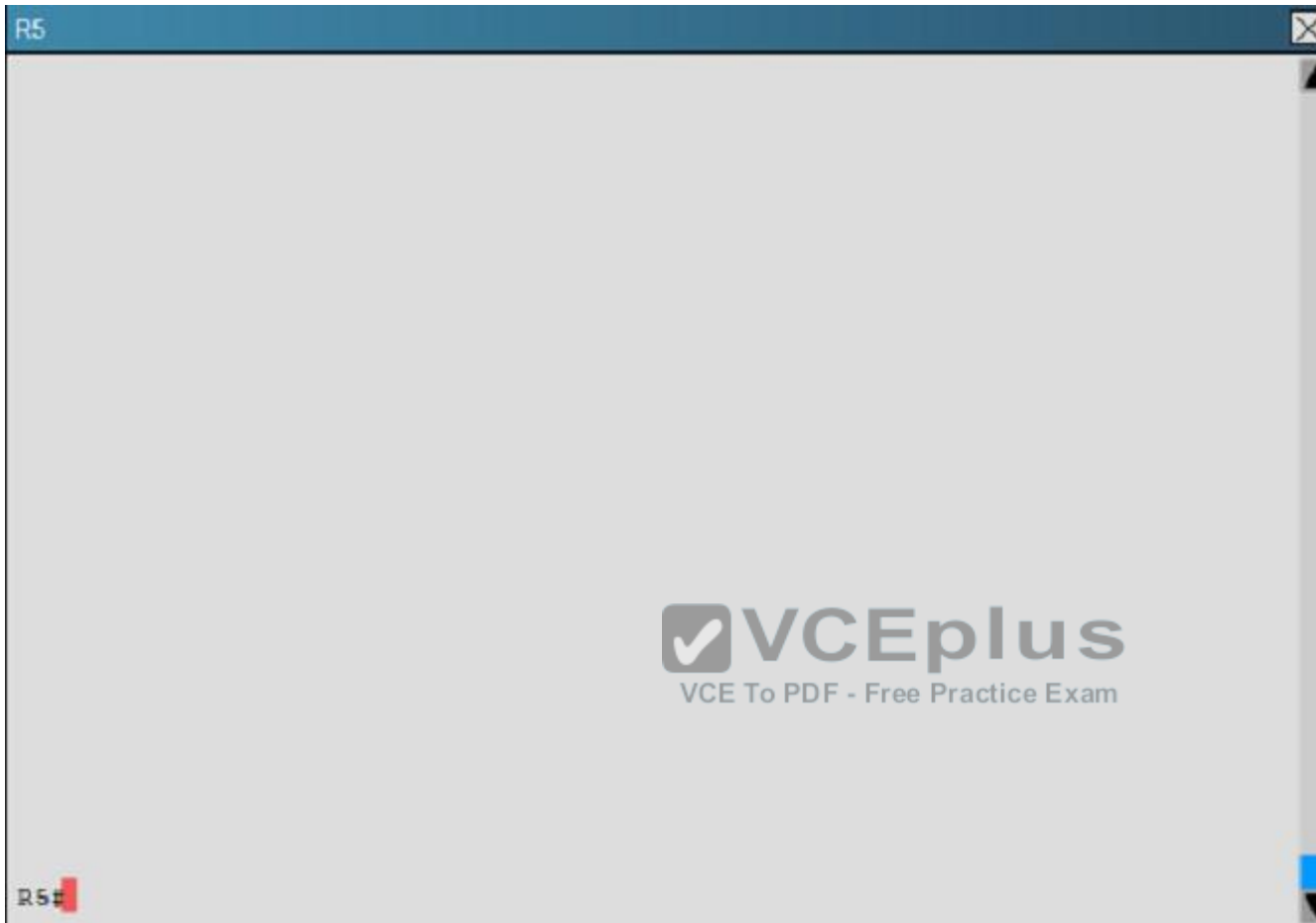



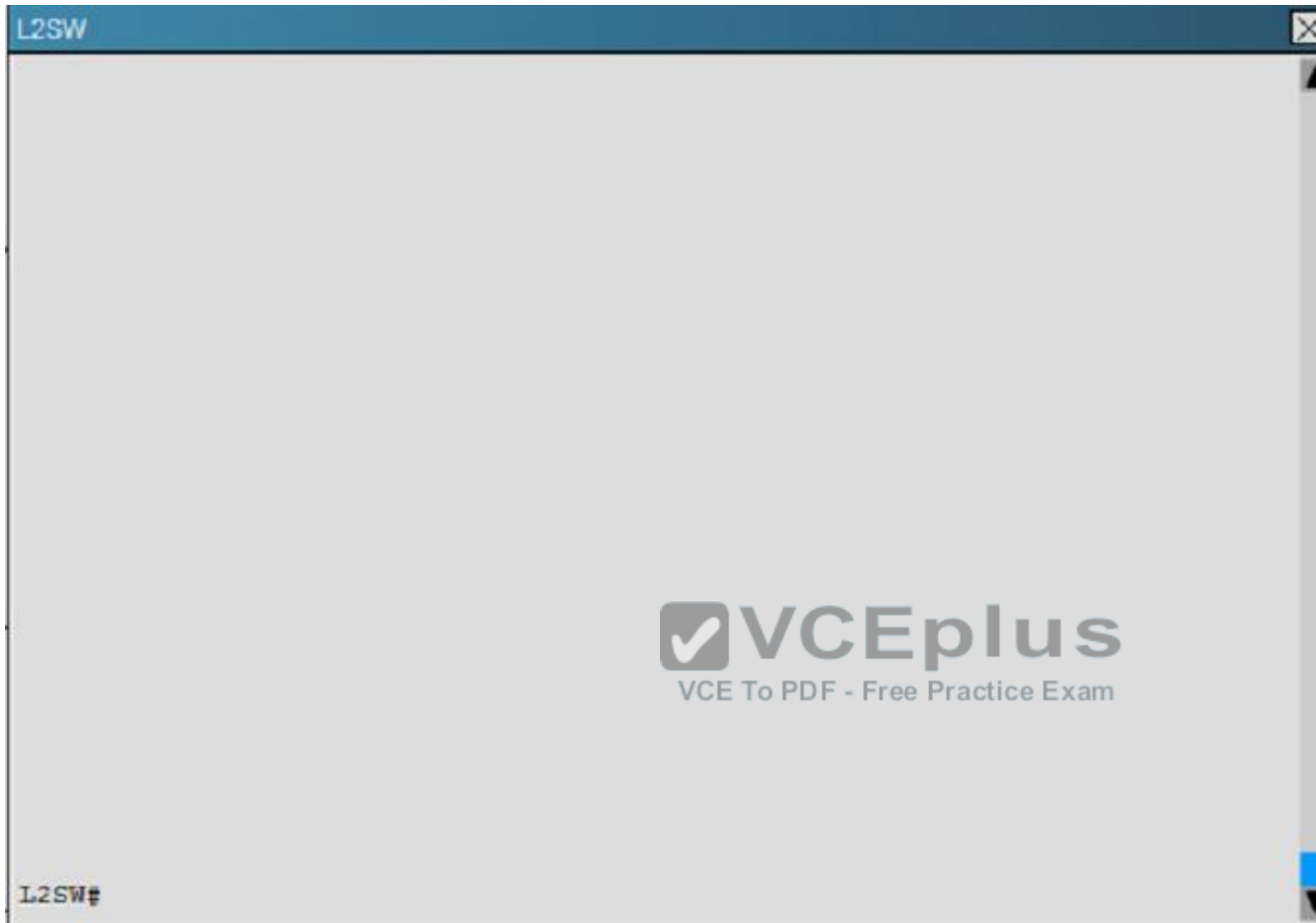

An OSPF neighbor adjacency is not formed between R3 in the main office and R4 in the Branch1 office. What is causing the problem?

- A. There is an area ID mismatch.
- B. There is a Layer 2 issue; an encapsulation mismatch on serial links.
- C. There is an OSPF hello and dead interval mismatch.
- D. The R3 router ID is configured on R4.

**Correct Answer:** A

**Section:** (none)

**Explanation**

**Explanation/Reference:**

Explanation:

Here are the relevant parts of the router configs:

```
R1interface Loopback0description ***Loopback***ip address 192.168.1.1 255.255.255.255ip ospf 1 area 0!interface Ethernet0/0description **Connected to R1-LAN**ip address 10.10.110.1 255.255.255.0ip ospf 1 area 0!interface Ethernet0/1description **Connected to L2SW**ip address 10.10.230.1 255.255.255.0ip ospf hello-interval 25ip ospf 1 area 0!router ospf 1log-adjacency-changes
R2!interface Loopback0description **Loopback**ip address 192.168.2.2 255.255.255.255ip ospf 2 area 0!interface Ethernet0/0description **Connected to R2-LAN**ip address 10.10.120.1 255.255.255.0ip ospf 2 area 0!interface Ethernet0/1description **Connected to L2SW**ip address 10.10.230.2 255.255.255.0ip ospf 2 area 0!router ospf 2log-adjacency-changes
R3username R6 password CISCO36!interface Loopback0description **Loopback**ip address 192.168.3.3 255.255.255.255ip ospf 3 area 0!interface Ethernet0/0description **Connected to L2SW**ip address 10.10.230.3 255.255.255.0ip ospf 3 area 0!interface Serial1/0description **Connected to R4-Branch1 office**ip address 10.10.240.1 255.255.255.252encapsulation pppip ospf 3 area 0!interface Serial1/1description **Connected to R5-Branch2 office**ip address 10.10.240.5 255.255.255.252encapsulation pppip ospf hello-interval 50ip ospf 3 area 0!interface Serial1/2description **Connected to R6-Branch3 office**ip address 10.10.240.9 255.255.255.252encapsulation pppip ospf 3 area 0ppp authentication chap!router ospf 3router-id 192.168.3.3!
R4!interface Loopback0description **Loopback**ip address 192.168.4.4 255.255.255.255ip ospf 4 area 2!interface Ethernet0/0ip address 172.16.113.1 255.255.255.0ip ospf 4 area 2!interface Serial1/0description **Connected to R3-Main Branch office**ip address 10.10.240.2 255.255.255.252encapsulation pppip ospf 4 area 2!router ospf 4log-adjacency-changes
R5!interface Loopback0description **Loopback**ip address 192.168.5.5 255.255.255.255ip ospf 5 area 0!interface Ethernet0/0ip address 172.16.114.1 255.255.255.0ip ospf 5 area 0!interface Serial1/0description **Connected to R3-Main Branch office**ip address 10.10.240.6 255.255.255.252encapsulation pppip ospf 5 area 0!router ospf 5log-adjacency-changes
R6username R3 password CISCO36!interface Loopback0description **Loopback**ip address 192.168.6.6 255.255.255.255ip ospf 6 area 0!interface Ethernet0/0ip address 172.16.115.1 255.255.255.0ip ospf 6 area 0!interface Serial1/0description **Connected to R3-Main Branch office**ip address 10.10.240.10 255.255.255.252encapsulation pppip ospf 6 area 0ppp authentication chap!router ospf 6router-id 192.168.3.3!
```

On both R3 and R4 use “show running-config” command to check their S1/0 interfaces

```
R3#show running-config<<output omitted>>!interface Serial1/0description **Connected to R4-Branch1 office**ip address 10.10.240.1 255.255.255.252encapsulation pppip ospf 3 area 0!<<output omitted>>
```

```
R4#show running-config<<output omitted>>!interface Serial1/0description **Connected to R3-Main Branch office**ip address 10.10.240.2 255.255.255.252encapsulation pppip ospf 4 area 2!<<output omitted>>
```

In the output above we see their Area IDs are mismatched; interface S1/0 of R3 is in area 0 (R3: ip ospf 3 area 0) while interface s1/0 of R4 is in area 2 (R4: ip ospf 4 area 2).

**QUESTION 15**

Scenario

Refer to the topology. Your company has decided to connect the main office with three other remote branch offices using point-to-point serial links.

You are required to troubleshoot and resolve OSPF neighbor adjacency issues between the main office and the routers located in the remote branch offices.

Use appropriate show commands to troubleshoot the issues and answer all four questions.



Instructions

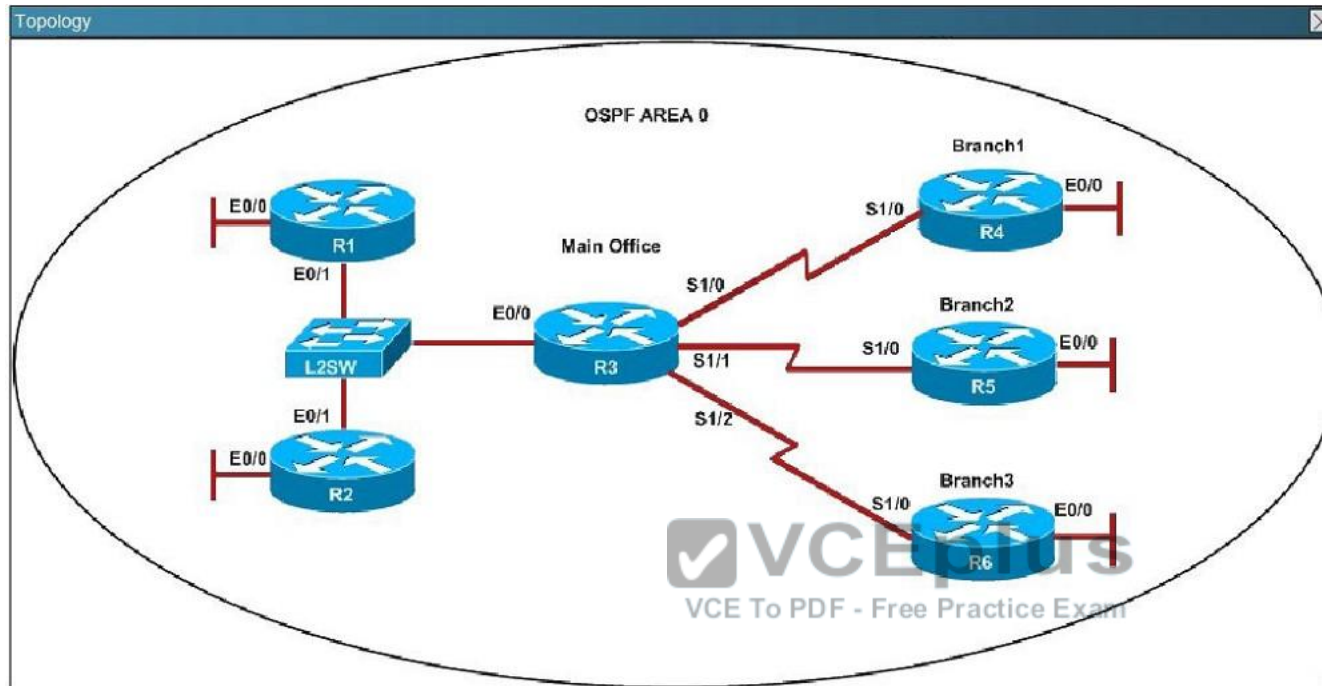

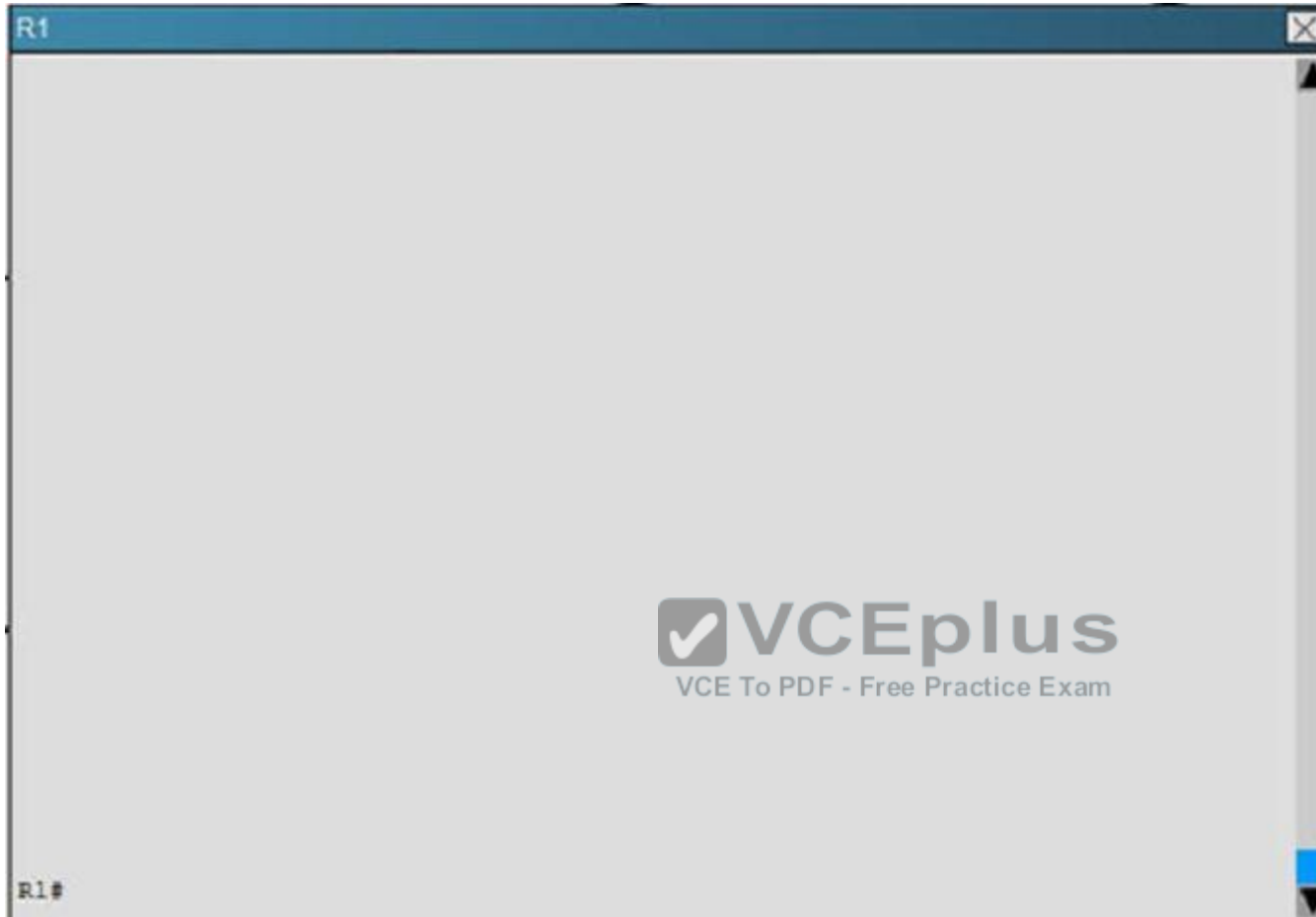

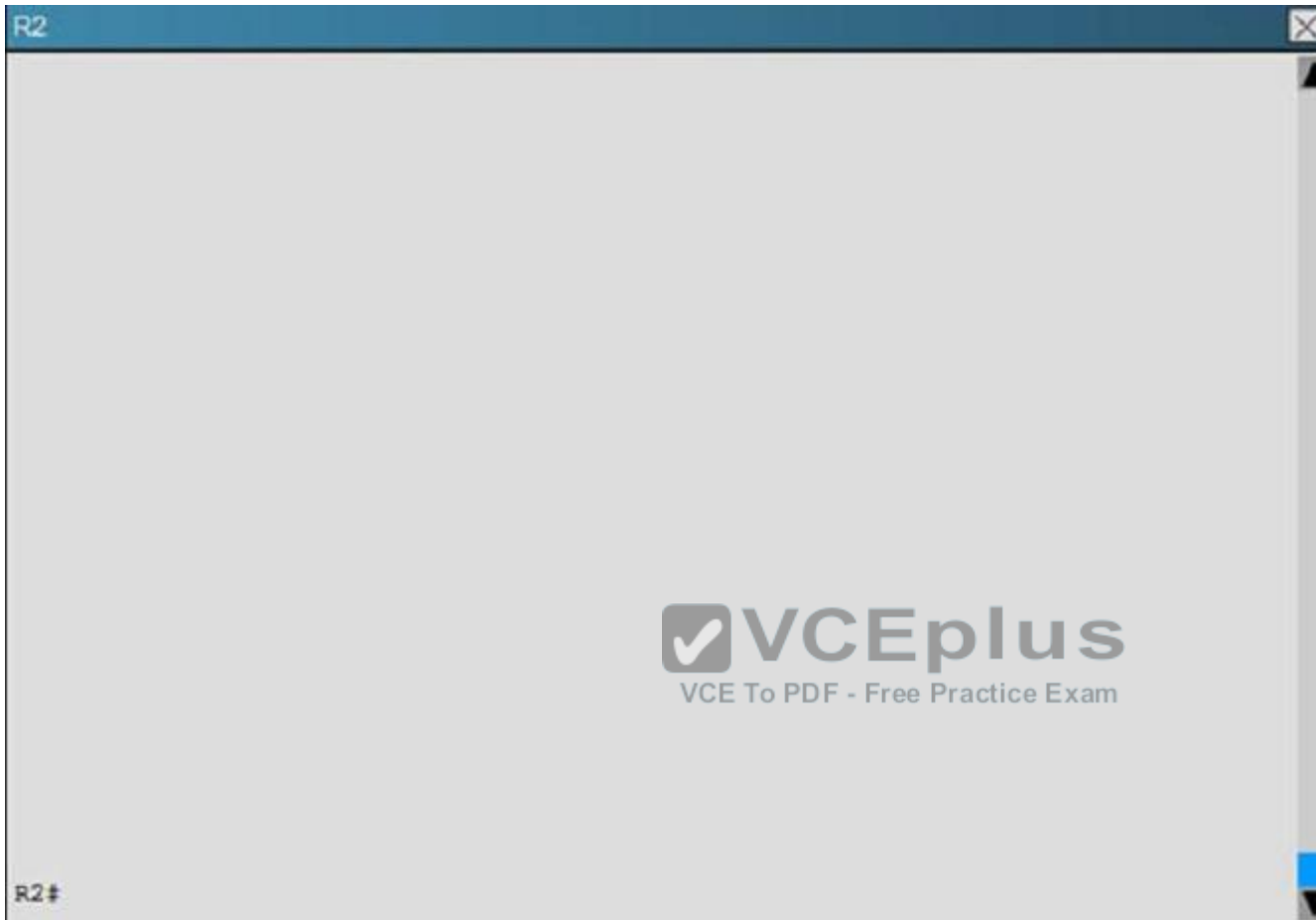

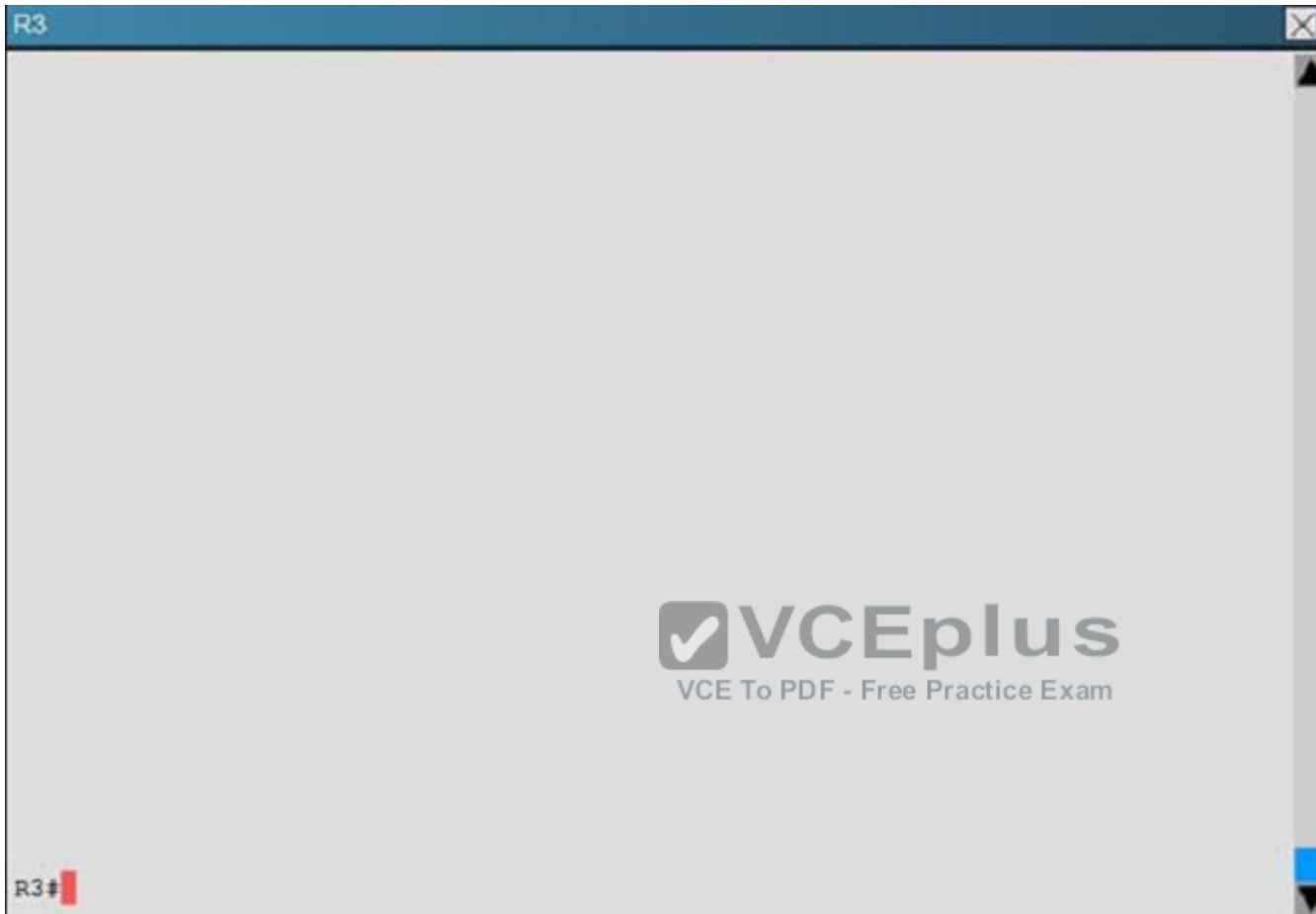

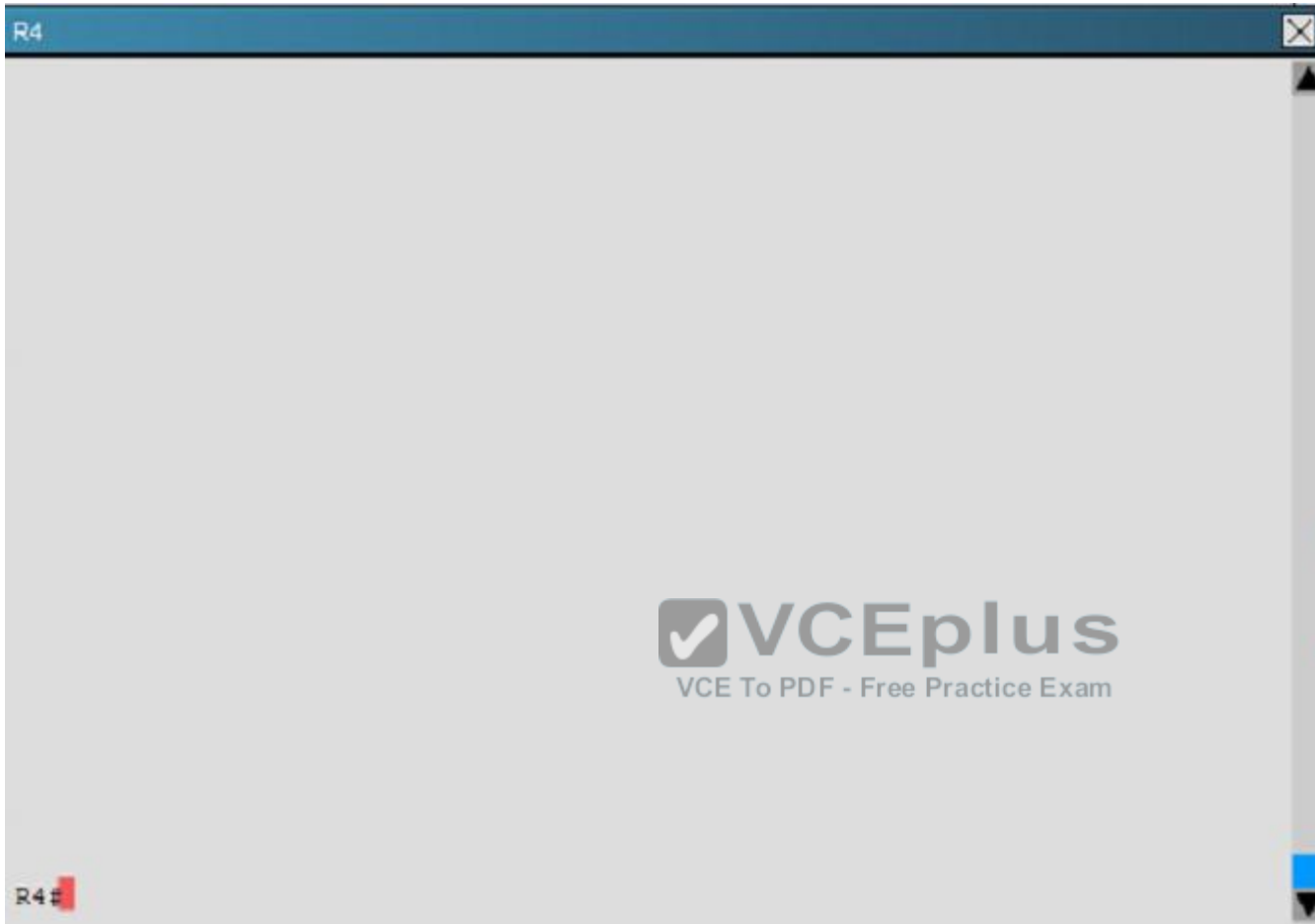

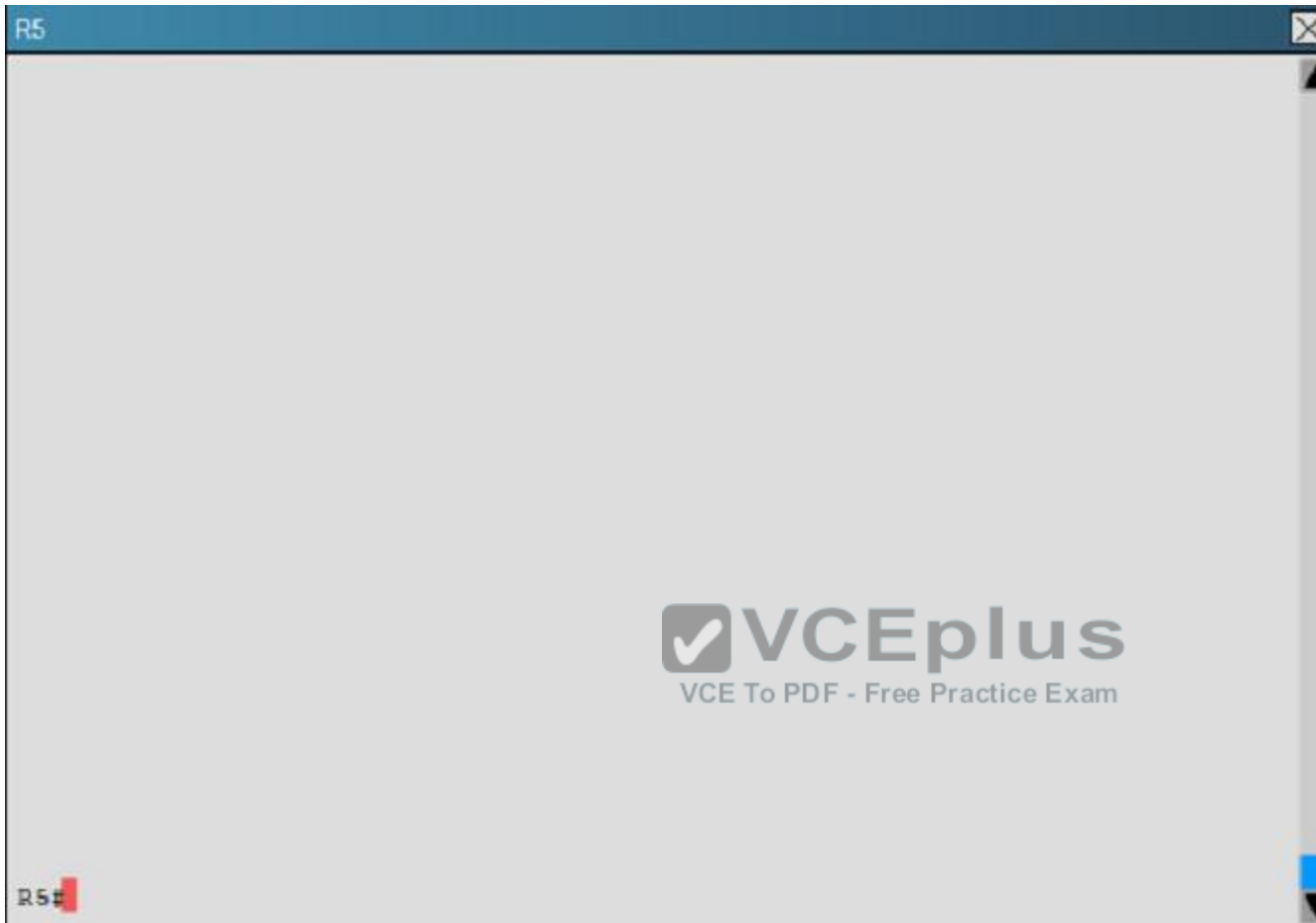



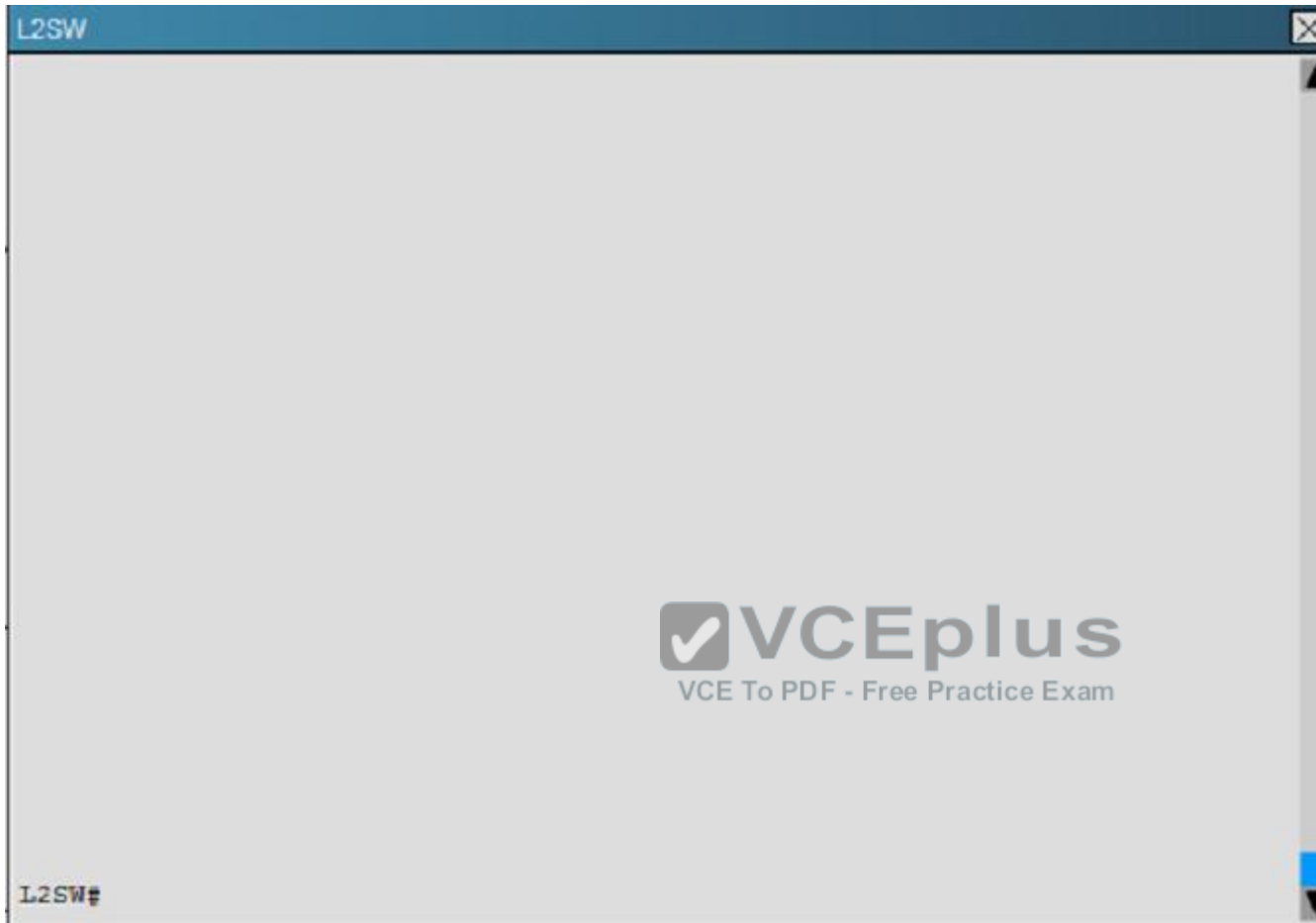

An OSPF neighbor adjacency is not formed between R3 in the main office and R5 in the Branch2 office. What is causing the problem?

- A. There is an area ID mismatch.
- B. There is a PPP authentication issue; a password mismatch.
- C. There is an OSPF hello and dead interval mismatch.
- D. There is a missing network command in the OSPF process on R5.

**Correct Answer:** C

**Section:** (none)

**Explanation**



**Explanation/Reference:**

Explanation:

Here are the relevant parts of the router configs:

```
R1interface Loopback0description ***Loopback***ip address 192.168.1.1 255.255.255.255ip ospf 1 area 0!interface Ethernet0/0description **Connected to R1-LAN**ip address 10.10.110.1 255.255.255.0ip ospf 1 area 0!interface Ethernet0/1description **Connected to L2SW**ip address 10.10.230.1 255.255.255.0ip ospf hello-interval 25ip ospf 1 area 0!router ospf 1log-adjacency-changes
R2!interface Loopback0description **Loopback**ip address 192.168.2.2 255.255.255.255ip ospf 2 area 0!interface Ethernet0/0description **Connected to R2-LAN**ip address 10.10.120.1 255.255.255.0ip ospf 2 area 0!interface Ethernet0/1description **Connected to L2SW**ip address 10.10.230.2 255.255.255.0ip ospf 2 area 0!router ospf 2log-adjacency-changes
R3username R6 password CISCO36!interface Loopback0description **Loopback**ip address 192.168.3.3 255.255.255.255ip ospf 3 area 0!interface Ethernet0/0description **Connected to L2SW**ip address 10.10.230.3 255.255.255.0ip ospf 3 area 0!interface Serial1/0description **Connected to R4-Branch1 office**ip address 10.10.240.1 255.255.255.252encapsulation pppip ospf 3 area 0!interface Serial1/1description **Connected to R5-Branch2 office**ip address 10.10.240.5 255.255.255.252encapsulation pppip ospf hello-interval 50ip ospf 3 area 0!interface Serial1/2description **Connected to R6-Branch3 office**ip address 10.10.240.9 255.255.255.252encapsulation pppip ospf 3 area 0ppp authentication chap!router ospf 3router-id 192.168.3.3!
R4!interface Loopback0description **Loopback**ip address 192.168.4.4 255.255.255.255ip ospf 4 area 2!interface Ethernet0/0ip address 172.16.113.1 255.255.255.0ip ospf 4 area 2!interface Serial1/0description **Connected to R3-Main Branch office**ip address 10.10.240.2 255.255.255.252encapsulation pppip ospf 4 area 2!router ospf 4log-adjacency-changes
R5!interface Loopback0description **Loopback**ip address 192.168.5.5 255.255.255.255ip ospf 5 area 0!interface Ethernet0/0ip address 172.16.114.1 255.255.255.0ip ospf 5 area 0!interface Serial1/0description **Connected to R3-Main Branch office**ip address 10.10.240.6 255.255.255.252encapsulation pppip ospf 5 area 0!router ospf 5log-adjacency-changes
R6username R3 password CISCO36!interface Loopback0description **Loopback**ip address 192.168.6.6 255.255.255.255ip ospf 6 area 0!interface Ethernet0/0ip address 172.16.115.1 255.255.255.0ip ospf 6 area 0!interface Serial1/0description **Connected to R3-Main Branch office**ip address 10.10.240.10 255.255.255.252encapsulation pppip ospf 6 area 0ppp authentication chap!router ospf 6router-id 192.168.3.3!
```

Continue checking their connected interfaces with the “show running-config” command:

```
R3#show running-config<<output omitted>>!interface Serial1/1description **Connected to R5-Branch2 office**ip address 10.10.240.5 255.255.255.252encapsulation pppip ospf hello-interval 50ip ospf 3 area 0!<<output omitted>>
```

```
R5#show running-config<<output omitted>>!interface Serial1/0description **Connected to R3-Main Branch office**ip address 10.10.240.6 255.255.255.252encapsulation pppip ospf 5 area 0!<<output omitted>>
```

The only difference we can see here is the line “ip ospf hello-interval 50” on R3. This command sets the number of seconds R3 waits before sending the next hello packet out this interface. In this case after configuring this command, R3 will send hello packets to R5 every 50 seconds. But the default value of hello-interval is 10 seconds and R5 is using it. Therefore we can think of a hello interval mismatch problem here. You can verify with the “show ip ospf interface <interface>” command on each router.

```
R3#sh ip ospf int s1/1Serial1/1 is up, line protocol is upInternet Address 10.10.240.5/30, Area 0Process ID 3, Router ID 192.168.3.3, Network Type POINT_TO_POINT, Cost: 64Enabled by interface config, including secondary ip addressesTransmit Delay is 1 sec, State POINT_TO_POINT,Timer intervals configured, Hello 50, Dead 200, Wait 200, Retransmit 5oob-resync timeout 200Hello due in 00:00:28Supports Link-local Signaling (LLS)Index 2/2, flood queue length 0Next 0x0(0)/0x0(0)Last flood scan length is 0, maximum is 0Last flood scan time is 0 msec, maximum is 0 msecNeighbor Count is 0, Adjacent neighbor count is 0Suppress hello for 0 neighbor(s)
```

R5#sh ip ospf int s1/0Serial1/0 is up, line protocol is upInternet Address 10.10.240.6/30, Area 0Process ID 5, Router ID 10.10.240.6, Network Type POINT\_TO\_POINT, Cost: 64Enabled by interface config, including secondary ip addressesTransmit Delay is 1 sec, State POINT\_TO\_POINT,Timer intervals configured, Hello 10, Dead 40, Wait 40, Retransmit 5ob-resync timeout 40Hello due in 00:00:04Supports Link-local Signaling (LLS)Index 1/1, flood queue length 0Next 0x0(0)/0x0(0)Last flood scan length is 0, maximum is 0Last flood scan time is 0 msec, maximum is 0 msecNeighbor Count is 0, Adjacent neighbor count is 0Suppress hello for 0 neighbor(s)  
So we can see both hello and dead interval are mismatched because the dead interval always four times the value of hello interval, unless you manually configure the dead interval (with the ip ospf dead-interval <seconds> command).

### QUESTION 16

#### Scenario

Refer to the topology. Your company has decided to connect the main office with three other remote branch offices using point-to-point serial links.

You are required to troubleshoot and resolve OSPF neighbor adjacency issues between the main office and the routers located in the remote branch offices.

Use appropriate show commands to troubleshoot the issues and answer all four questions.

#### Instructions

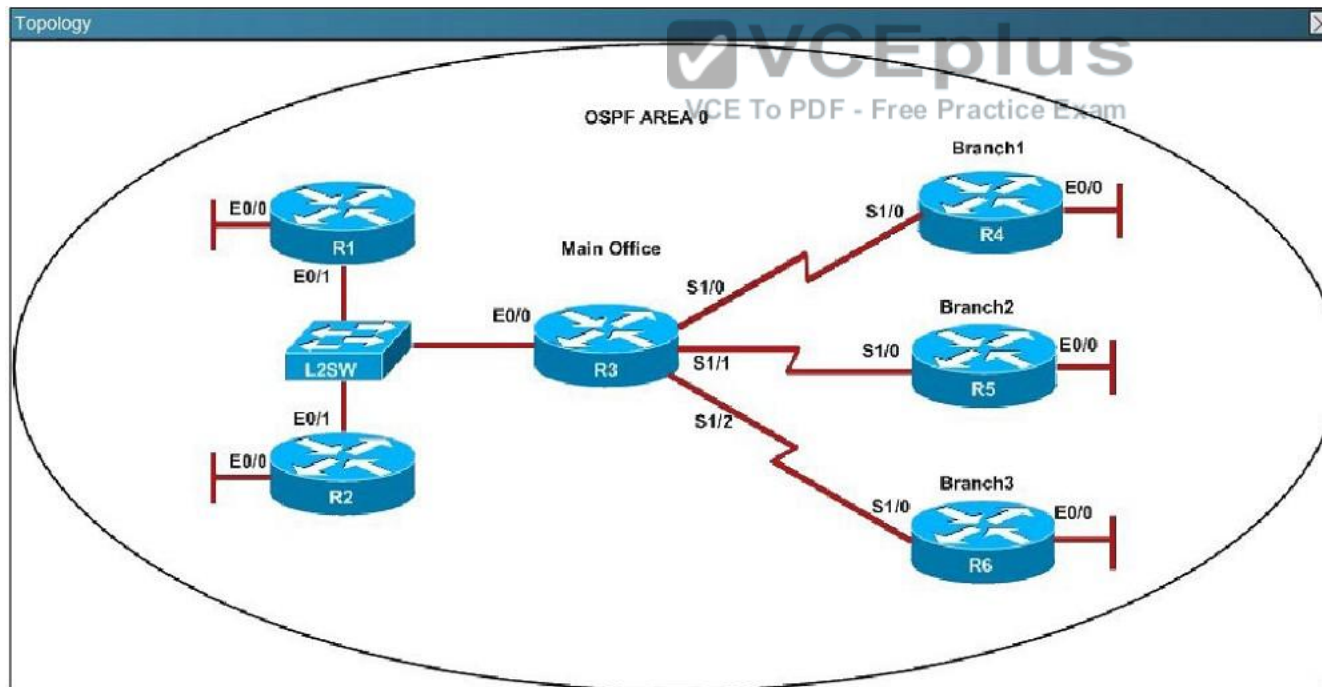

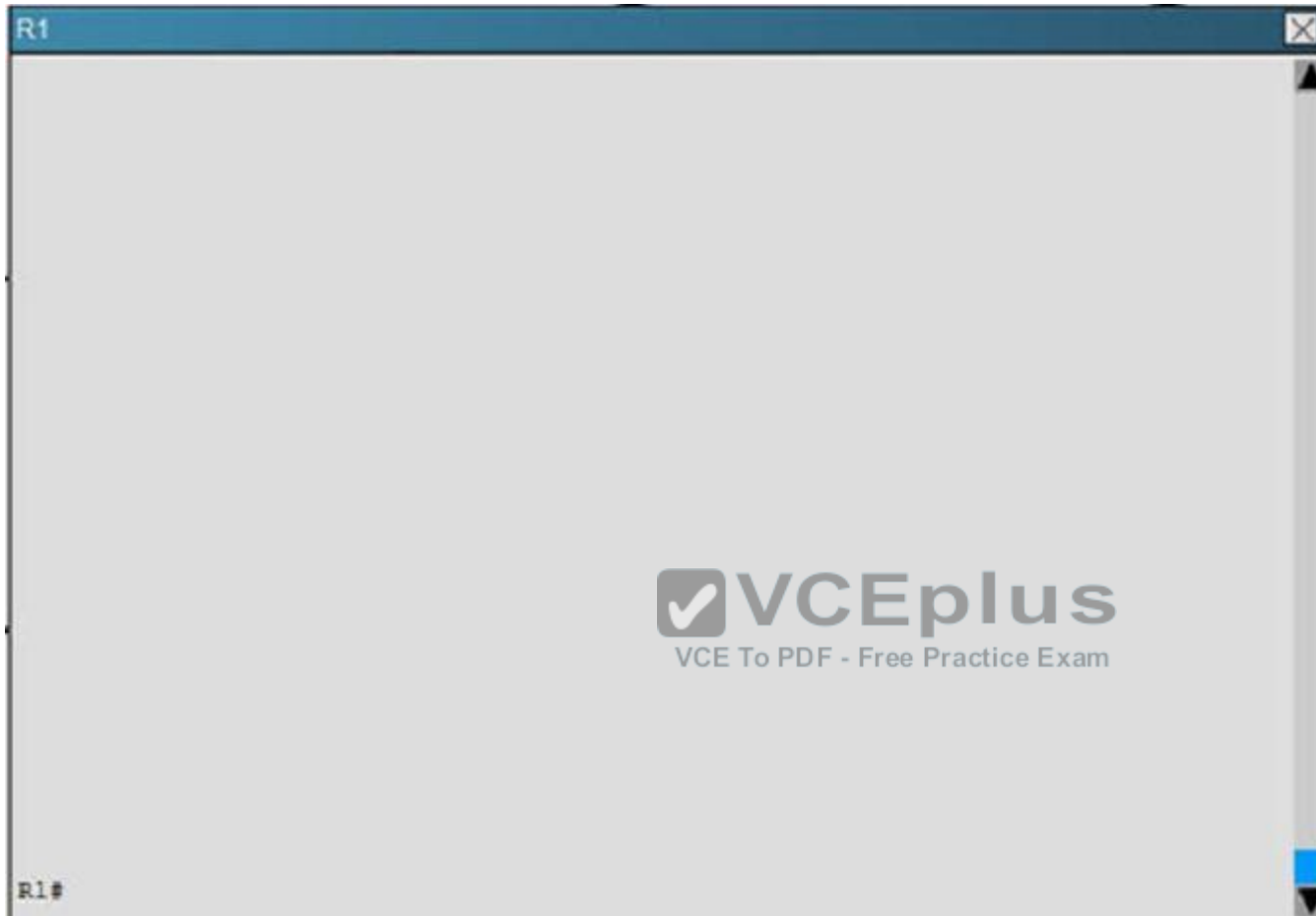

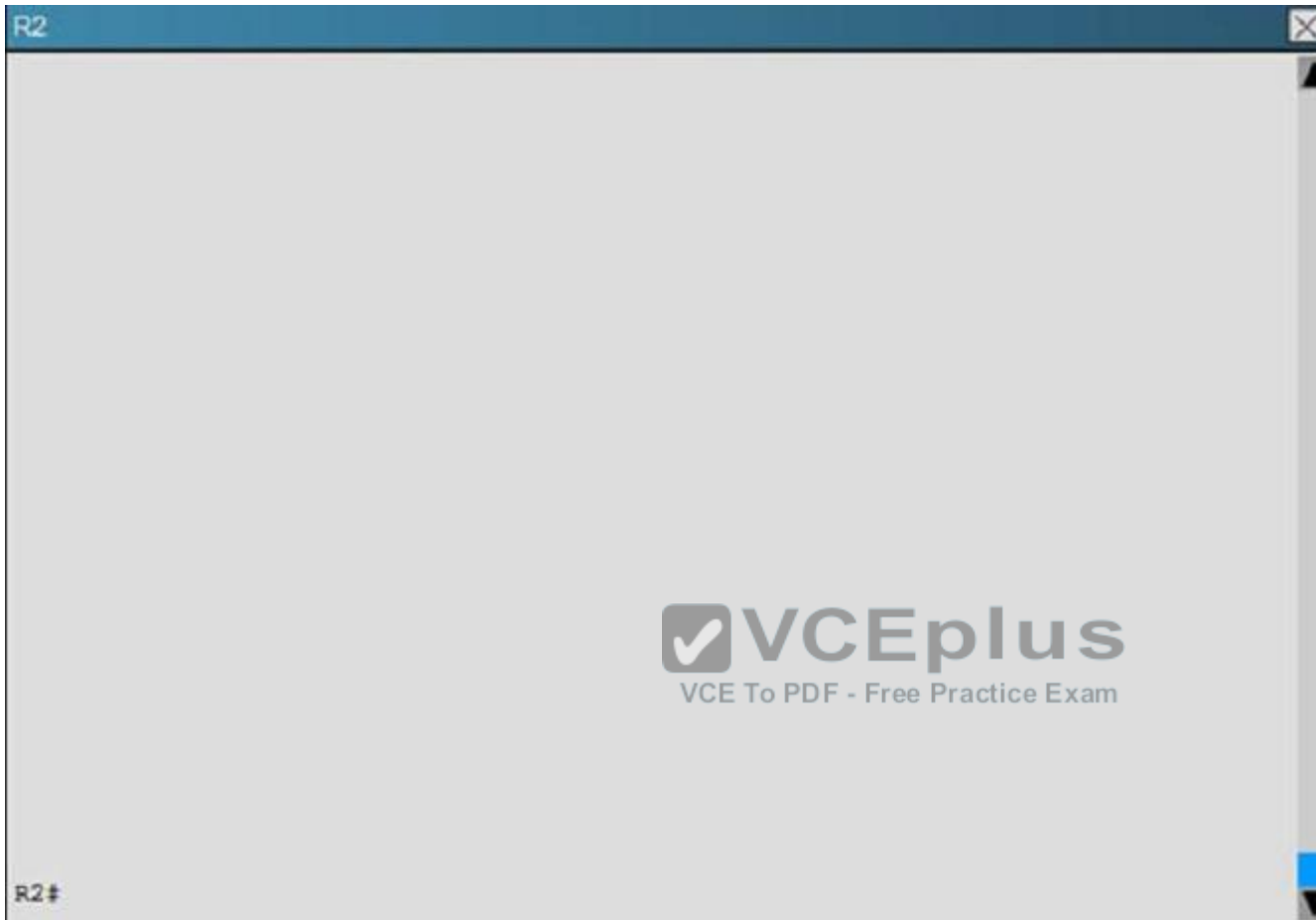

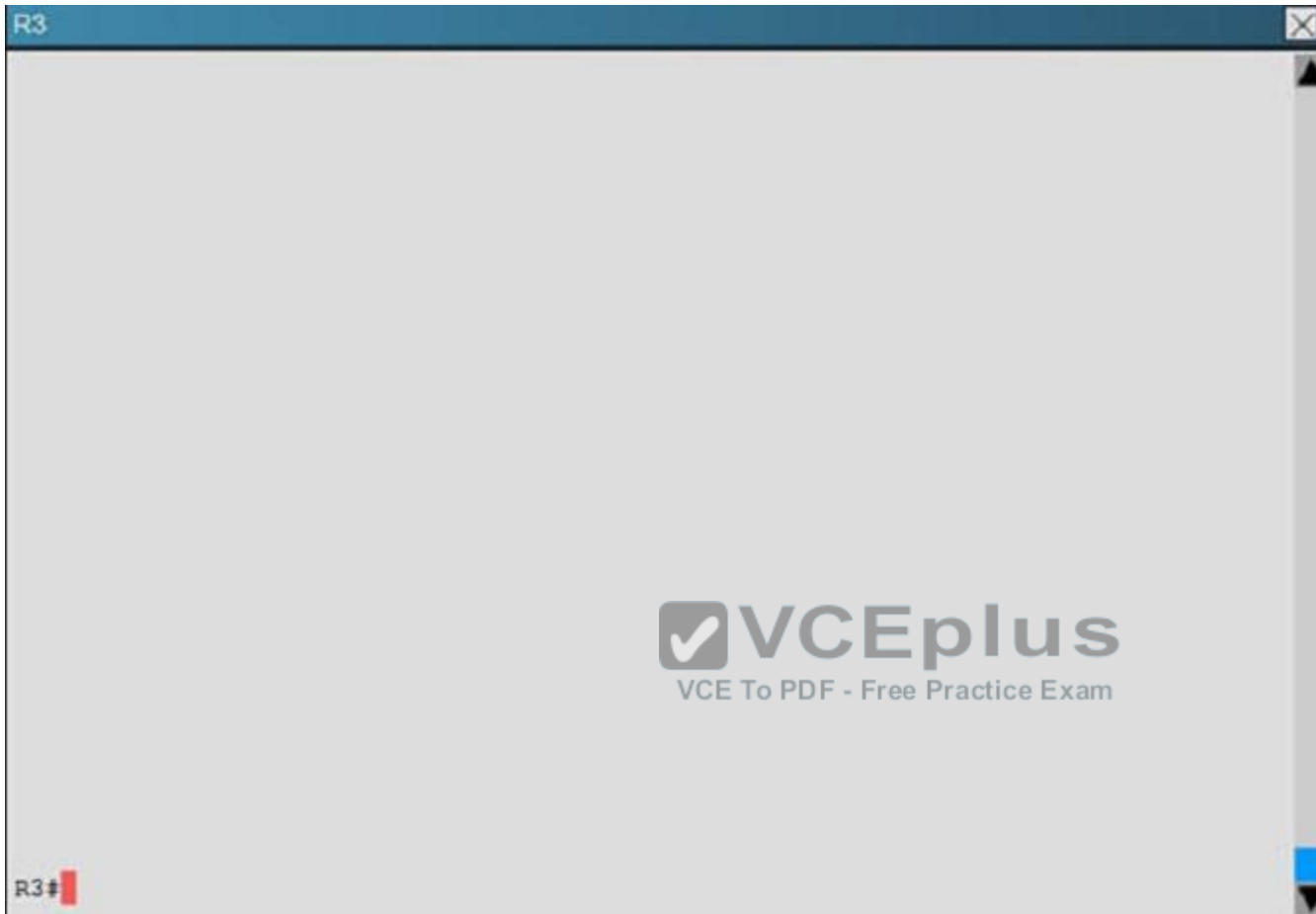

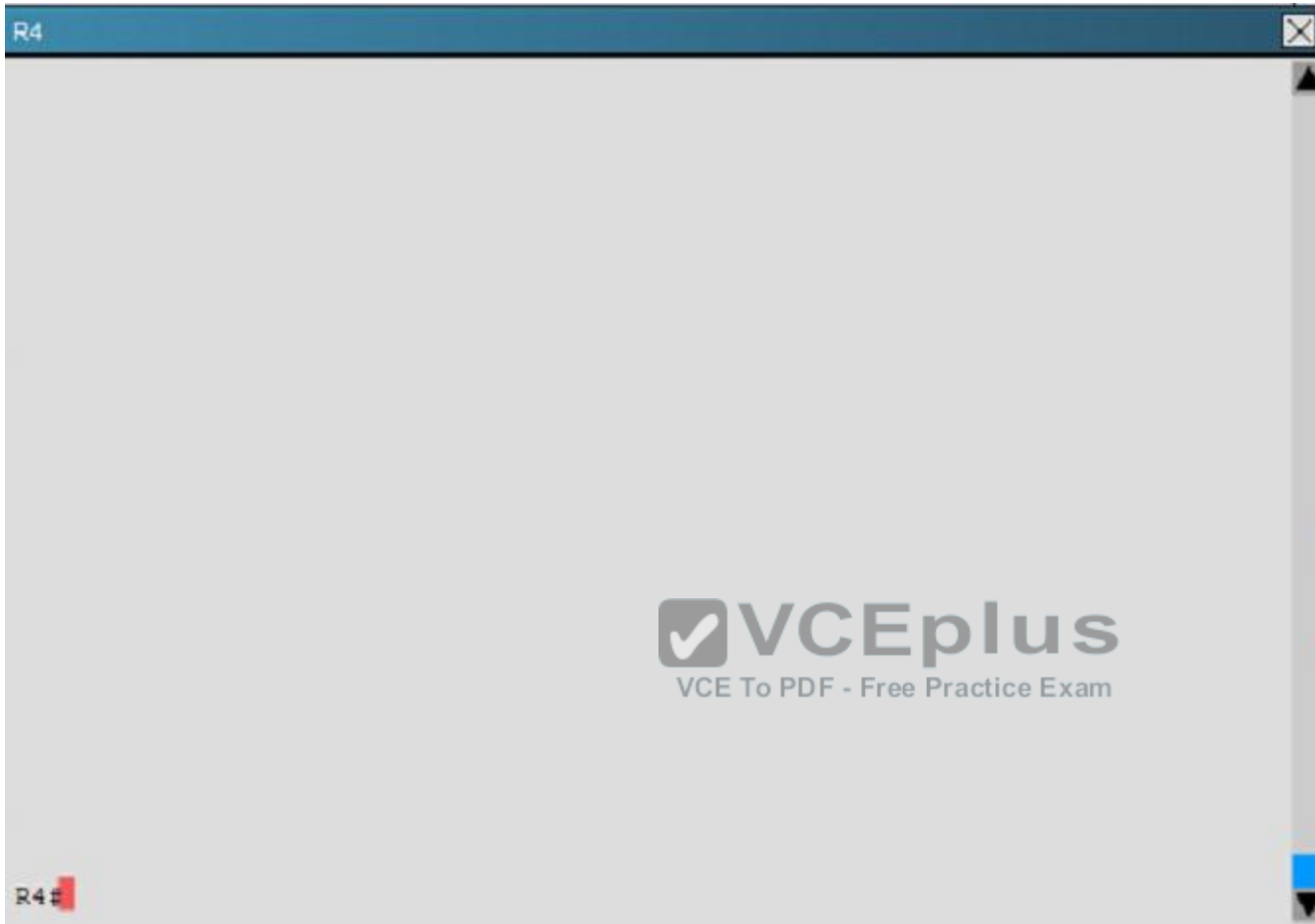

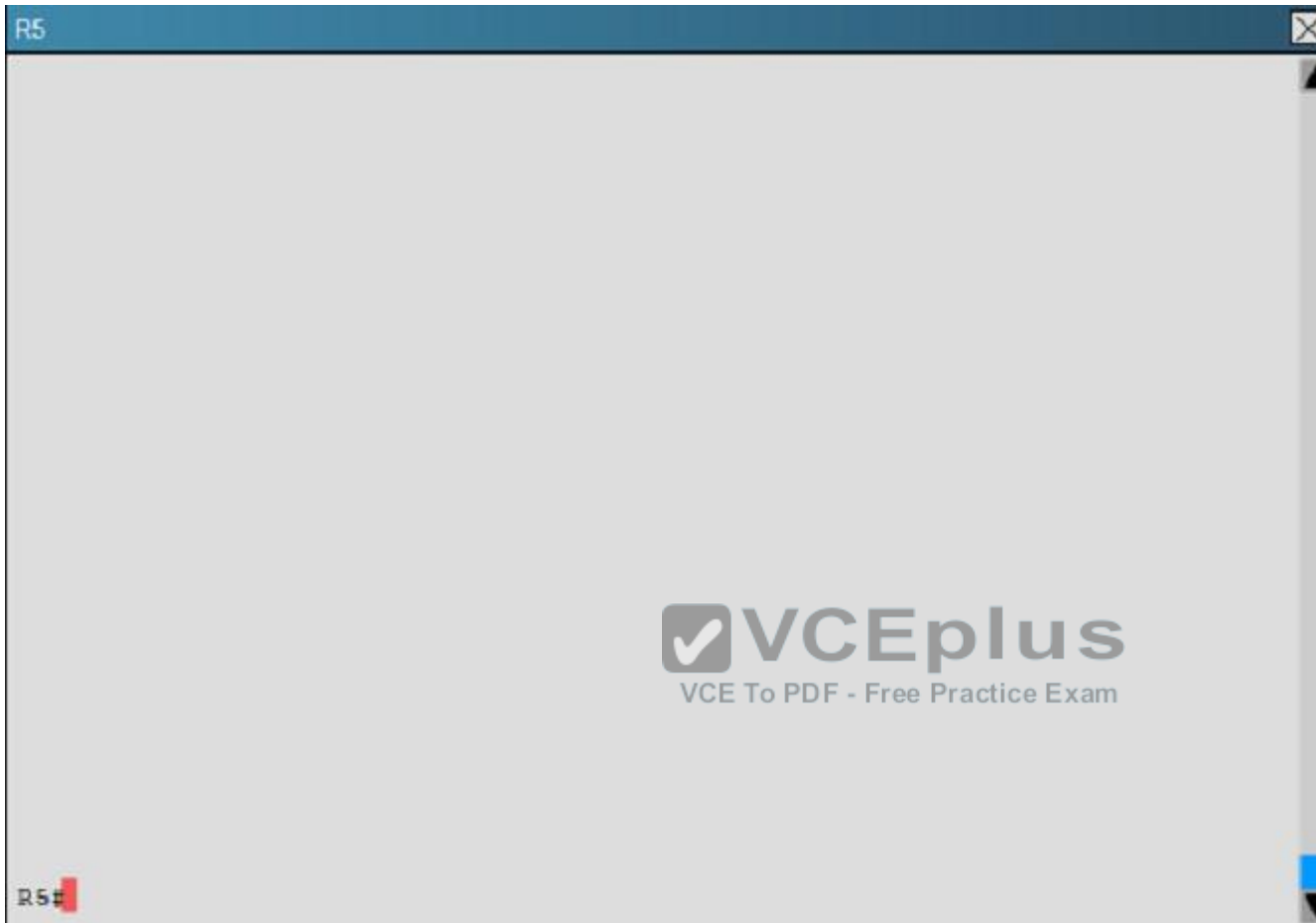





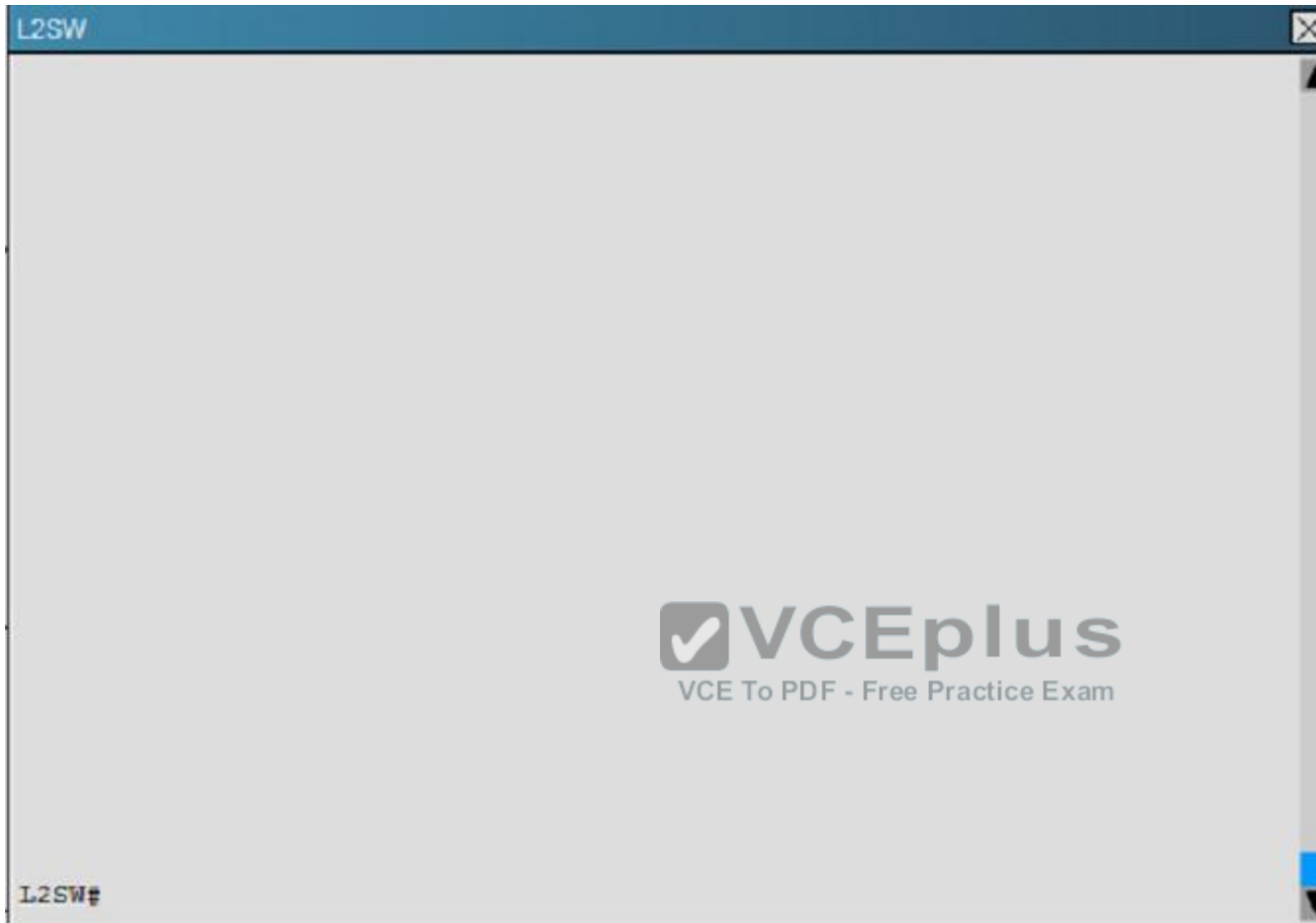

R1 does not form an OSPF neighbor adjacency with R2. Which option would fix the issue?

- A. R1 ethernet0/1 is shutdown. Configure no shutdown command.
- B. R1 ethernet0/1 configured with a non-default OSPF hello interval of 25; configure no ip ospf hello-interval 25
- C. R2 ethernet0/1 and R3 ethernet0/0 are configured with a non-default OSPF hello interval of 25; configure no ip ospf hello-interval 25
- D. Enable OSPF for R1 ethernet0/1; configure ip ospf 1 area 0 command under ethernet0/1.

**Correct Answer:** B

**Section:** (none)

**Explanation**

**Explanation/Reference:**

Explanation:

Here are the relevant parts of the router configs:

```
R1interface Loopback0description ***Loopback***ip address 192.168.1.1 255.255.255.255ip ospf 1 area 0!interface Ethernet0/0description **Connected to R1-LAN**ip address 10.10.110.1 255.255.255.0ip ospf 1 area 0!interface Ethernet0/1description **Connected to L2SW**ip address 10.10.230.1 255.255.255.0ip ospf hello-interval 25ip ospf 1 area 0!router ospf 1log-adjacency-changes
R2!interface Loopback0description **Loopback**ip address 192.168.2.2 255.255.255.255ip ospf 2 area 0!interface Ethernet0/0description **Connected to R2-LAN**ip address 10.10.120.1 255.255.255.0ip ospf 2 area 0!interface Ethernet0/1description **Connected to L2SW**ip address 10.10.230.2 255.255.255.0ip ospf 2 area 0!router ospf 2log-adjacency-changes
R3username R6 password CISCO36!interface Loopback0description **Loopback**ip address 192.168.3.3 255.255.255.255ip ospf 3 area 0!interface Ethernet0/0description **Connected to L2SW**ip address 10.10.230.3 255.255.255.0ip ospf 3 area 0!interface Serial1/0description **Connected to R4-Branch1 office**ip address 10.10.240.1 255.255.255.252encapsulation pppip ospf 3 area 0!interface Serial1/1description **Connected to R5-Branch2 office**ip address 10.10.240.5 255.255.255.252encapsulation pppip ospf hello-interval 50ip ospf 3 area 0!interface Serial1/2description **Connected to R6-Branch3 office**ip address 10.10.240.9 255.255.255.252encapsulation pppip ospf 3 area 0ppp authentication chap!router ospf 3router-id 192.168.3.3!
R4!interface Loopback0description **Loopback**ip address 192.168.4.4 255.255.255.255ip ospf 4 area 2!interface Ethernet0/0ip address 172.16.113.1 255.255.255.0ip ospf 4 area 2!interface Serial1/0description **Connected to R3-Main Branch office**ip address 10.10.240.2 255.255.255.252encapsulation pppip ospf 4 area 2!router ospf 4log-adjacency-changes
R5!interface Loopback0description **Loopback**ip address 192.168.5.5 255.255.255.255ip ospf 5 area 0!interface Ethernet0/0ip address 172.16.114.1 255.255.255.0ip ospf 5 area 0!interface Serial1/0description **Connected to R3-Main Branch office**ip address 10.10.240.6 255.255.255.252encapsulation pppip ospf 5 area 0!router ospf 5log-adjacency-changes
R6username R3 password CISCO36!interface Loopback0description **Loopback**ip address 192.168.6.6 255.255.255.255ip ospf 6 area 0!interface Ethernet0/0ip address 172.16.115.1 255.255.255.0ip ospf 6 area 0!interface Serial1/0description **Connected to R3-Main Branch office**ip address 10.10.240.10 255.255.255.252encapsulation pppip ospf 6 area 0ppp authentication chap!router ospf 6router-id 192.168.3.3!
```

Continue checking their connected interfaces with the “show running-config” command:

```
R1#show running-config<<output omitted>>!interface Ethernet0/1description **Connected to L2SW**ip address 10.10.230.1 255.255.255.0ip ospf hello-interval 25ip ospf 1 area 0!<<output omitted>>
```

```
R2#show running-config<<output omitted>>!interface Ethernet0/1description **Connected to L2SW**ip address 10.10.230.2 255.255.255.0ip ospf 2 area 0!<<output omitted>>
```

We see the hello interval on R1 is not the same as R2 (and you can verify with the “show ip ospf interface <interface> command”) -> There is a hello and dead interval mismatch problem. We should configure “no ip ospf hello-interval 25 on R1.

Note: Maybe there are some versions of this question in the exam. For example there are some reports saying that Ethernet0/1 on R1 is shutdown (and this is the correct choice in the exam). So please be careful checking the config on the routers before choosing the correct answers.

**QUESTION 17**

Scenario

Refer to the topology. Your company has decided to connect the main office with three other remote branch offices using point-to-point serial links.

You are required to troubleshoot and resolve OSPF neighbor adjacency issues between the main office and the routers located in the remote branch

offices.

Use appropriate show commands to troubleshoot the issues and answer all four questions.

Instructions

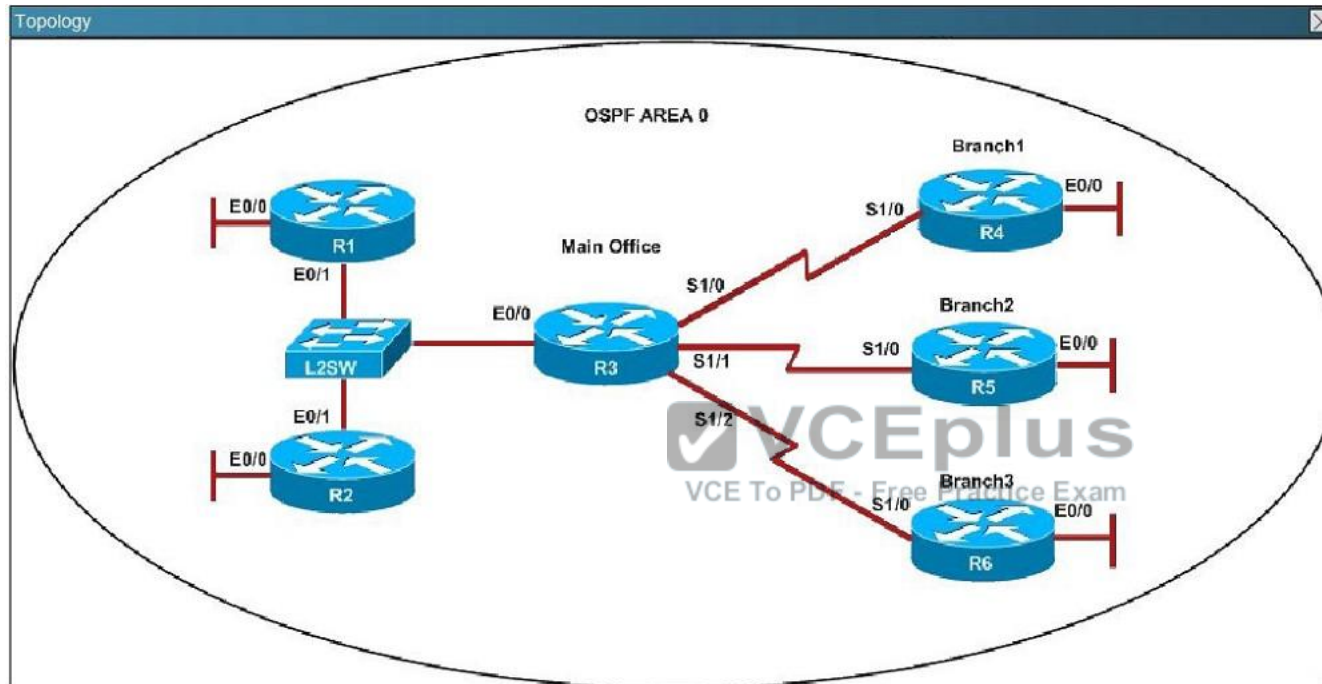

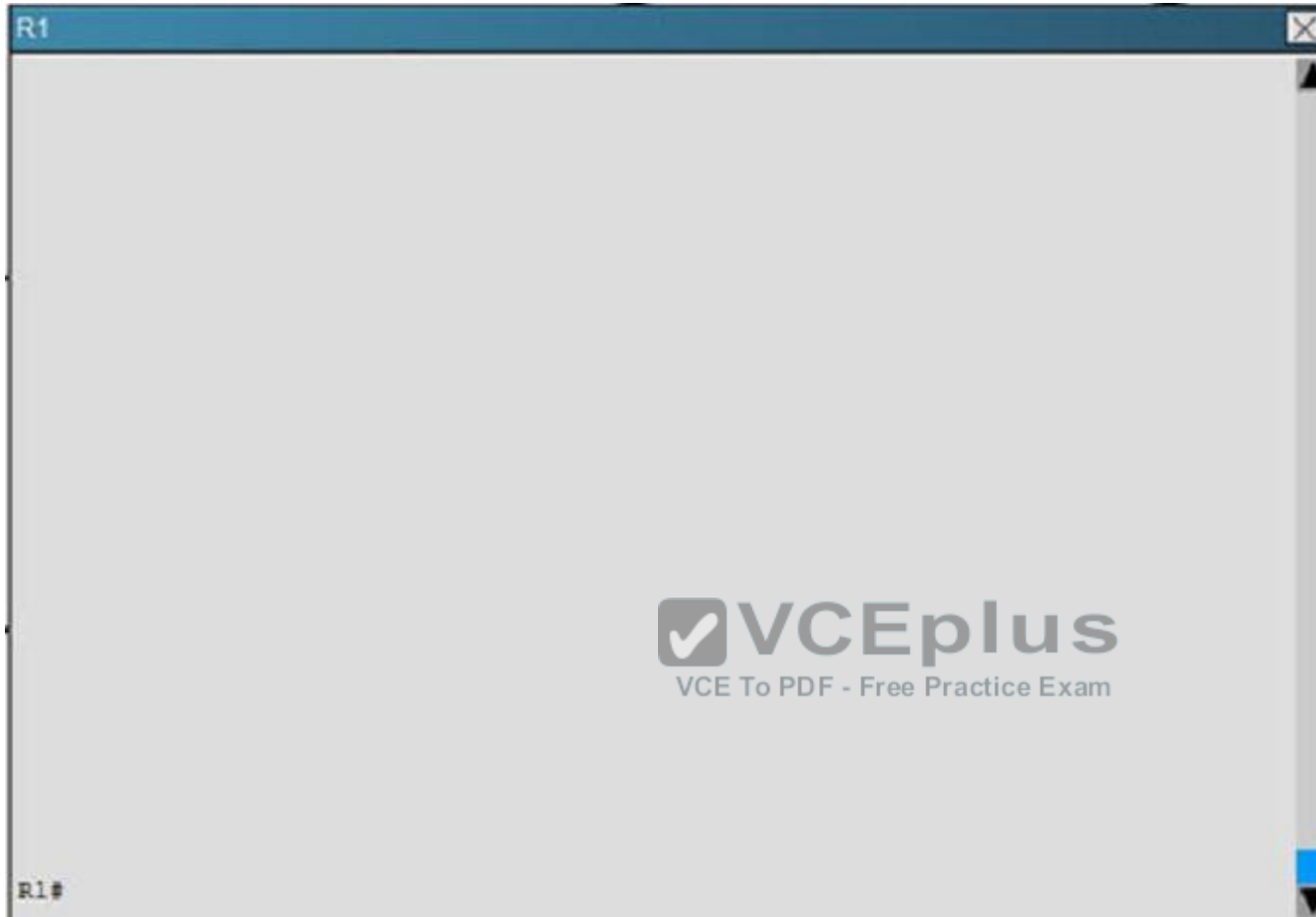

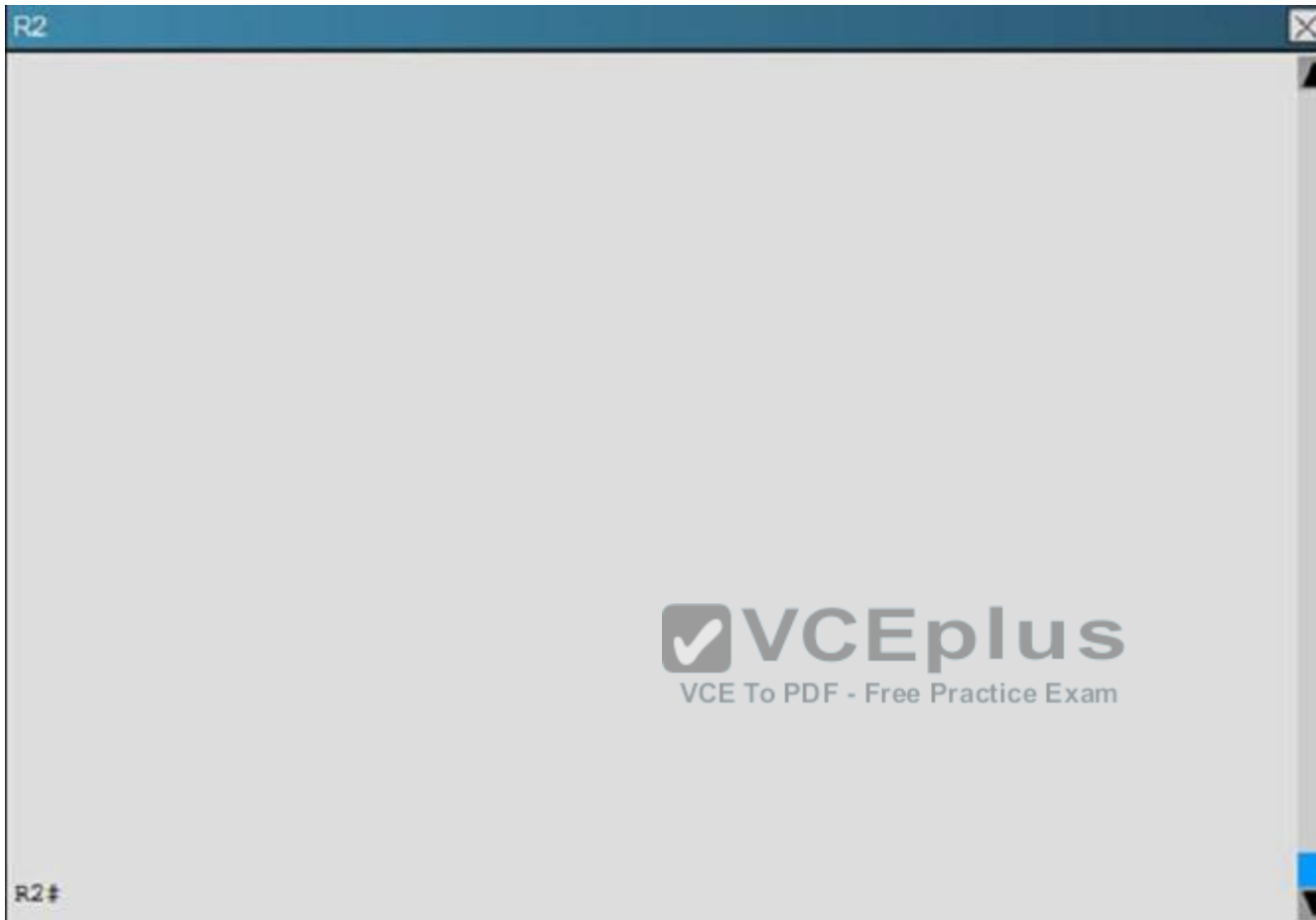

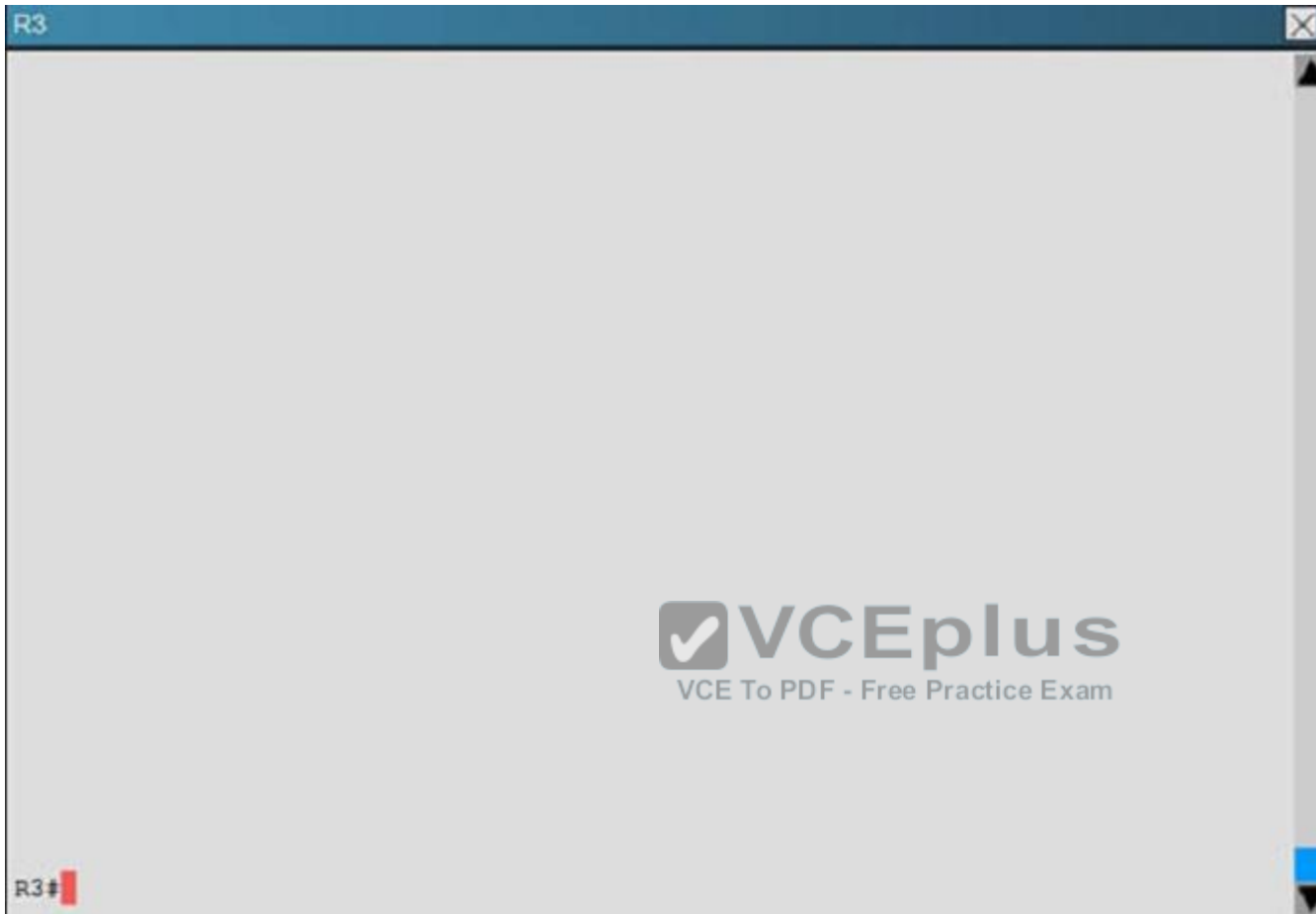

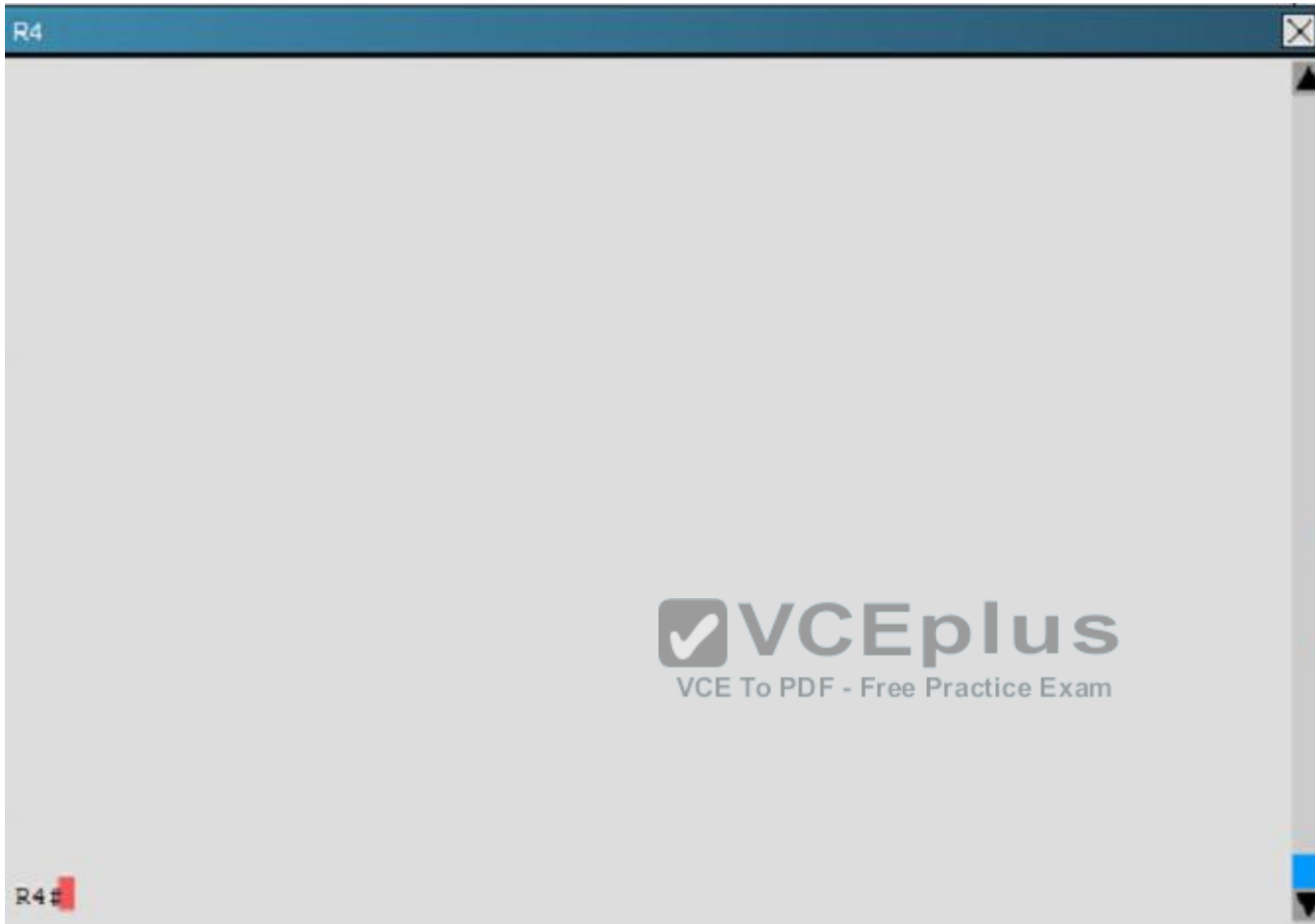

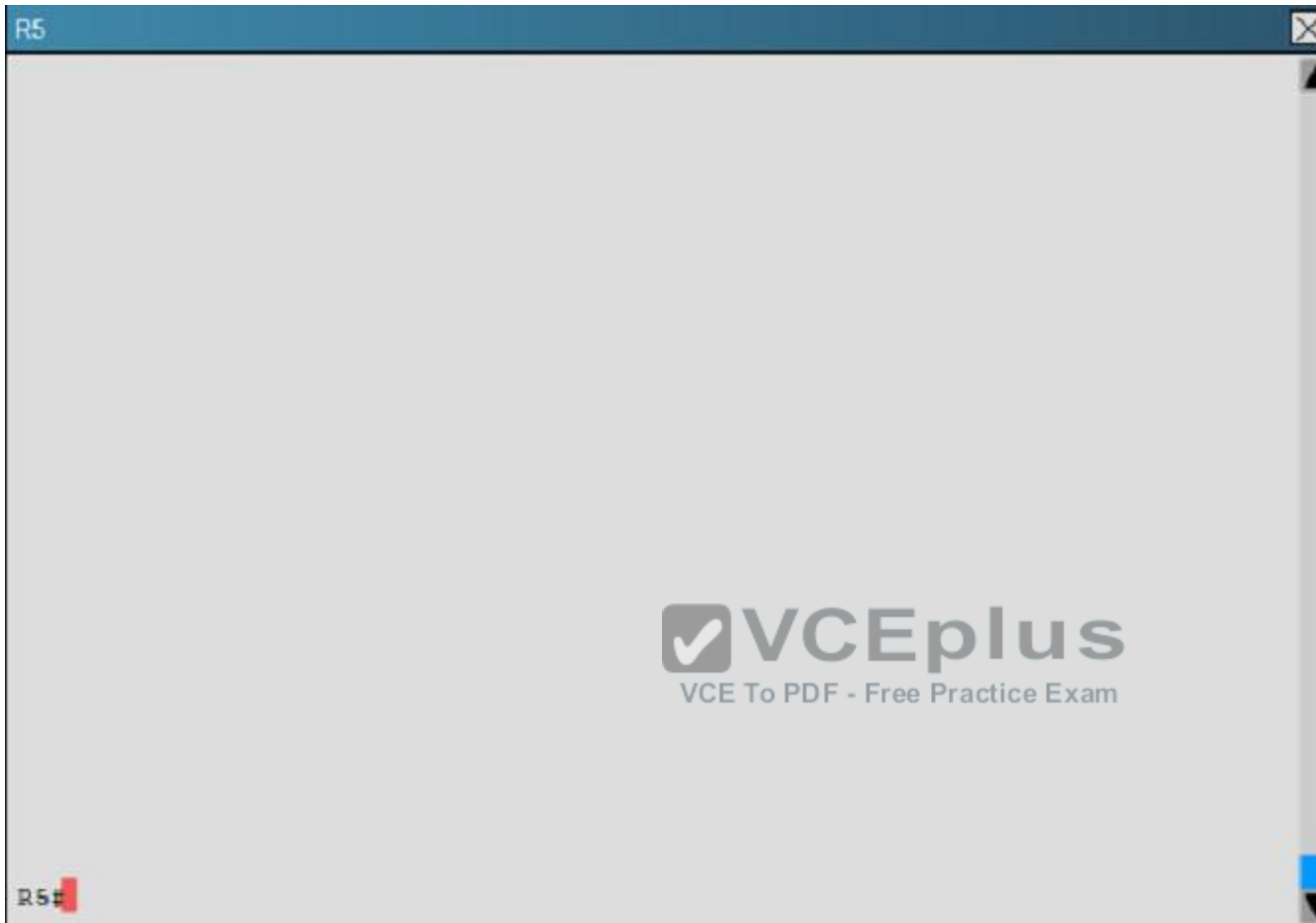





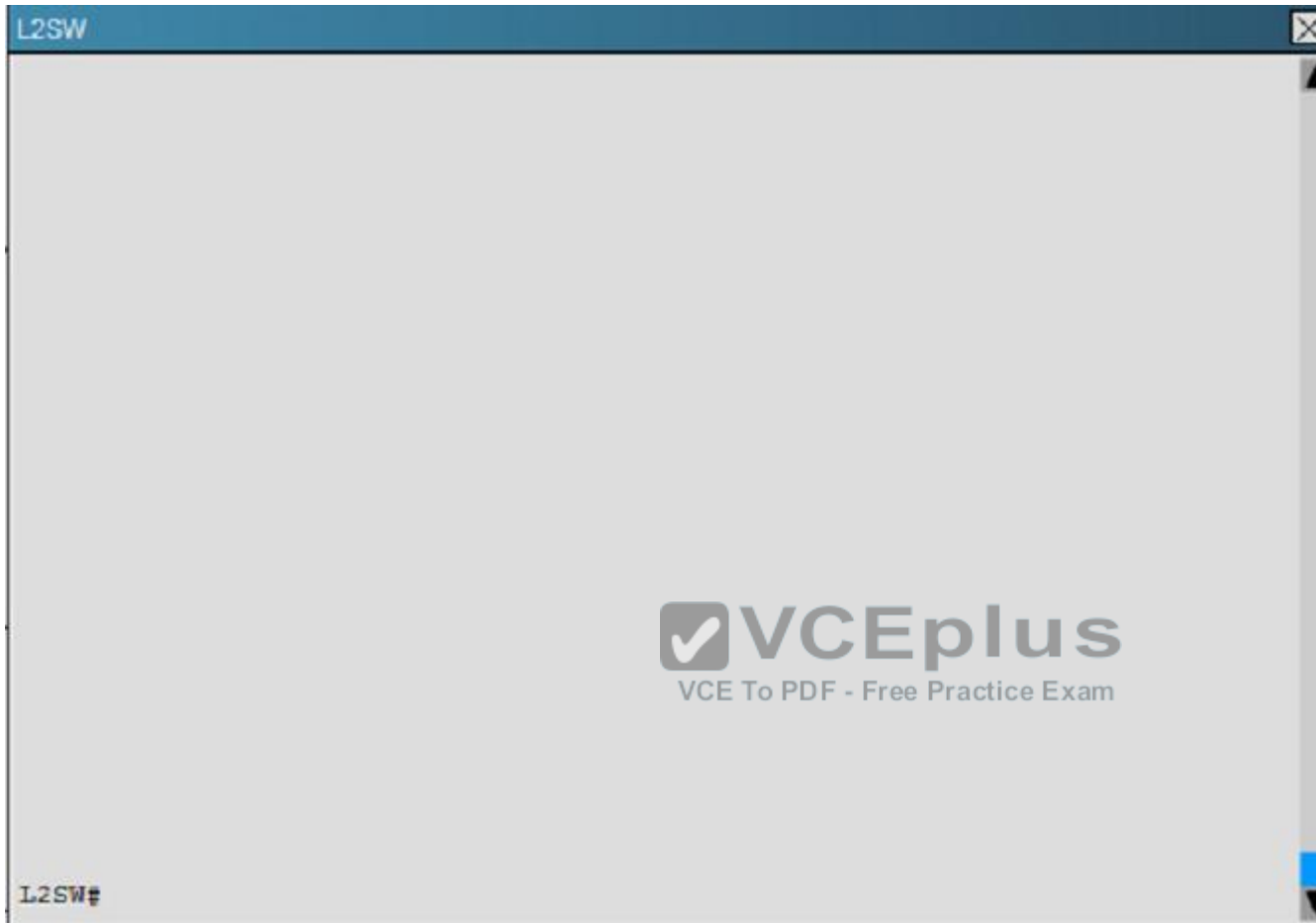

An OSPF neighbor adjacency is not formed between R3 in the main office and R6 in the Branch3 office. What is causing the problem?

- A. There is an area ID mismatch.
- B. There is a PPP authentication issue; the username is not configured on R3 and R6.
- C. There is an OSPF hello and dead interval mismatch.
- D. The R3 router ID is configured on R6.

**Correct Answer:** D

**Section:** (none)

**Explanation**

**Explanation/Reference:**

Explanation:

Here are the relevant parts of the router configs:

```
R1interface Loopback0description ***Loopback***ip address 192.168.1.1 255.255.255.255ip ospf 1 area 0!interface Ethernet0/0description **Connected to R1-LAN**ip address 10.10.110.1 255.255.255.0ip ospf 1 area 0!interface Ethernet0/1description **Connected to L2SW**ip address 10.10.230.1 255.255.255.0ip ospf hello-interval 25ip ospf 1 area 0!router ospf 1log-adjacency-changes
R2!interface Loopback0description **Loopback**ip address 192.168.2.2 255.255.255.255ip ospf 2 area 0!interface Ethernet0/0description **Connected to R2-LAN**ip address 10.10.120.1 255.255.255.0ip ospf 2 area 0!interface Ethernet0/1description **Connected to L2SW**ip address 10.10.230.2 255.255.255.0ip ospf 2 area 0!router ospf 2log-adjacency-changes
R3username R6 password CISCO36!interface Loopback0description **Loopback**ip address 192.168.3.3 255.255.255.255ip ospf 3 area 0!interface Ethernet0/0description **Connected to L2SW**ip address 10.10.230.3 255.255.255.0ip ospf 3 area 0!interface Serial1/0description **Connected to R4-Branch1 office**ip address 10.10.240.1 255.255.255.252encapsulation pppip ospf 3 area 0!interface Serial1/1description **Connected to R5-Branch2 office**ip address 10.10.240.5 255.255.255.252encapsulation pppip ospf hello-interval 50ip ospf 3 area 0!interface Serial1/2description **Connected to R6-Branch3 office**ip address 10.10.240.9 255.255.255.252encapsulation pppip ospf 3 area 0ppp authentication chap!router ospf 3router-id 192.168.3.3!
R4!interface Loopback0description **Loopback**ip address 192.168.4.4 255.255.255.255ip ospf 4 area 2!interface Ethernet0/0ip address 172.16.113.1 255.255.255.0ip ospf 4 area 2!interface Serial1/0description **Connected to R3-Main Branch office**ip address 10.10.240.2 255.255.255.252encapsulation pppip ospf 4 area 2!router ospf 4log-adjacency-changes
R5!interface Loopback0description **Loopback**ip address 192.168.5.5 255.255.255.255ip ospf 5 area 0!interface Ethernet0/0ip address 172.16.114.1 255.255.255.0ip ospf 5 area 0!interface Serial1/0description **Connected to R3-Main Branch office**ip address 10.10.240.6 255.255.255.252encapsulation pppip ospf 5 area 0!router ospf 5log-adjacency-changes
R6username R3 password CISCO36!interface Loopback0description **Loopback**ip address 192.168.6.6 255.255.255.255ip ospf 6 area 0!interface Ethernet0/0ip address 172.16.115.1 255.255.255.0ip ospf 6 area 0!interface Serial1/0description **Connected to R3-Main Branch office**ip address 10.10.240.10 255.255.255.252encapsulation pppip ospf 6 area 0ppp authentication chap!router ospf 6router-id 192.168.3.3!
```

```
R3#show running-config<<output omitted>>username R6 password CISCO36!interface Serial1/2description **Connected to R6-Branch3 office**ip address 10.10.240.9 255.255.255.252encapsulation pppip ospf 3 area 0ppp authentication chap!<<output omitted>>!router ospf 3router-id 192.168.3.3!<<output omitted>>
```

```
R6#show running-config<<output omitted>>username R3 password CISCO36!interface Serial1/0description **Connected to R3-Main Branch office**ip address 10.10.240.10 255.255.255.252encapsulation pppip ospf 6 area 0ppp authentication chap!<<output omitted>>!router ospf 6router-id 192.168.3.3!<<output omitted>>
```

We are not sure about the configuration of ppp authentication in this case. Some reports said that only one router has the “ppp authentication chap” command but it is just a trick and is not the problem here. The real problem here is R6 uses the same router-id of R3 (192.168.3.3) so OSPF neighborhood cannot be established. In real life, such configuration error will be shown in the command line interface (CLI). So please check carefully for this question.

**QUESTION 18**

What are three advantages of VLANs? (Choose three.)

A. They establish broadcast domains in switched networks.

- B. They provide a low-latency internetworking alternative to routed networks.
- C. They utilize packet filtering to enhance network security.
- D. They can simplify adding, moving, or changing hosts on the network.
- E. They allow access to network services based on department, not physical location.
- F. They provide a method of conserving IP addresses in large networks.

**Correct Answer:** ADE

**Section:** (none)

**Explanation**

**Explanation/Reference:**

Explanation:

#### **QUESTION 19**

Which command can you enter to determine whether serial interface 0/2/0 has been configured using HDLC encapsulation?

- A. router#show platform
- B. router#show interfaces Serial 0/2/0
- C. router#show ip interface s0/2/0
- D. router#show ip interface brief

**Correct Answer:** B

**Section:** (none)

**Explanation**

**Explanation/Reference:**

Explanation:

#### **QUESTION 20**

Which function of the IP SLAs ICMP jitter operation can you use to determine whether a VoIP issue is caused by excessive end-to-end time?

- A. packet loss
- B. jitter
- C. successive packet loss
- D. round-trip time latency

**Correct Answer:** D

**Section:** (none)

**Explanation**

**Explanation/Reference:**

Explanation:

**QUESTION 21**

Refer to the exhibit.

```
00:00:39: %LINEPROTO-5-UPDOWN: Line protocol on Interface Vlan1, changed state to down
00:00:40: %SPANTREE-5-EXTENDED_SYSID: Extended SysId enabled for type vlan
00:00:42: %SYS-5-CONFIG_I: Configured from memory by console
00:00:42: %SYS-5-RESTART: System restarted --
Cisco IOS Software, C2960 Software (C2960-LANBASEK9-M), Version 12.2(25)SEE2, RELEASE SOFTWARE (fc.1)
Copyright (c) 1986-2006 by Cisco Systems, Inc.
Compiled Fri 28-Jul-06 11:57 by yenh
00:00:44: %LINK-5-CHANGED: Interface Vlan1, changed state to administratively down
00:00:44: %LINK-3-UPDOWN: Interface FastEthernet0/1, changed state to up
00:00:44: %LINK-3-UPDOWN: Interface FastEthernet0/2, changed state to up
00:00:44: %LINK-3-UPDOWN: Interface FastEthernet0/11, changed state to up
00:00:45: %LINEPROTO-5-UPDOWN: Line protocol on Interface FastEthernet0/1, changed state to up
00:00:45: %LINEPROTO-5-UPDOWN: Line protocol on Interface FastEthernet0/2, changed state to up
00:00:45: %LINEPROTO-5-UPDOWN: Line protocol on Interface FastEthernet0/11, changed state to up
00:00:48: %LINK-3-UPDOWN: Interface FastEthernet0/12, changed state to up
00:00:49: %LINEPROTO-5-UPDOWN: Line protocol on Interface FastEthernet0/12, changed state to up
```

Which of these statements correctly describes the state of the switch once the boot process has been completed?

- A. The switch will need a different IOS code in order to support VLANs and STP .
- B. Remote access management of this switch will not be possible without configuration change.
- C. As FastEthernet0/12 will be the last to come up, it will be blocked by STP.
- D. More VLANs will need to be created for this switch.

**Correct Answer:** B

**Section:** (none)

**Explanation**

**Explanation/Reference:**

Explanation:

**QUESTION 22**

Refer to the exhibit.

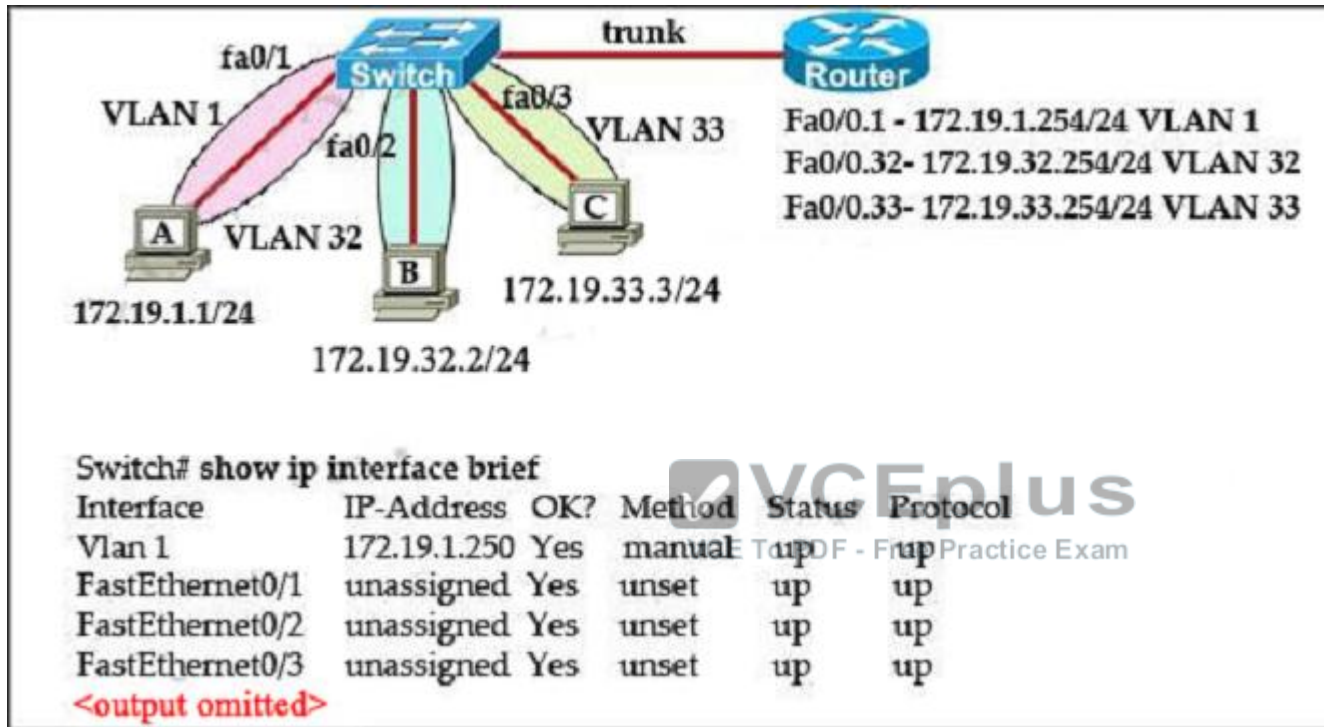

The network administrator normally establishes a Telnet session with the switch from host A. However, host A is unavailable. The administrator's attempt to telnet to the switch from host B fails, but pings to the other two hosts are successful. What is the issue?

- A. The switch interfaces need the appropriate IP addresses assigned.
- B. Host B and the switch need to be in the same subnet.
- C. The switch needs an appropriate default gateway assigned.
- D. The switch interface connected to the router is down.
- E. Host B needs to be assigned an IP address in VLAN 1.

**Correct Answer: C**

**Section: (none)**

**Explanation**

**Explanation/Reference:**

Explanation:

**QUESTION 23**

Which condition does the err-disabled status indicate on an Ethernet interface?

- A. There is a duplex mismatch.
- B. The device at the other end of the connection is powered off.
- C. The serial interface is disabled.
- D. The interface is configured with the shutdown command.
- E. Port security has disabled the interface.
- F. The interface is fully functioning.

**Correct Answer:** E

**Section:** (none)

**Explanation**

**Explanation/Reference:**

Explanation:

**QUESTION 24**

Which statement about RADIUS security is true?

- A. It supports EAP authentication for connecting to wireless networks.
- B. It provides encrypted multiprotocol support.
- C. Device-administration packets are encrypted in their entirety.
- D. It ensures that user activity is fully anonymous.

**Correct Answer:** A

**Section:** (none)

**Explanation**

**Explanation/Reference:**

Explanation:

**QUESTION 25**

A router has learned three possible routes that could be used to reach a destination network. One route is from EIGRP and has a composite metric of 20514560. Another route is from OSPF with a metric of 782. The last is from RIPv2 and has a metric of 4. Which route or routes will the router install in the routing table?

- A. the RIPv2 route
- B. all three routes
- C. the OSPF and RIPv2 routes
- D. the OSPF route
- E. the EIGRP route

**Correct Answer:** E

**Section:** (none)

**Explanation**

**Explanation/Reference:**

Explanation:

#### **QUESTION 26**

Which two correctly describe steps in the OSI data encapsulation process? (Choose two.)

- A. The presentation layer translates bits into voltages for transmission across the physical link.
- B. The data link layer adds physical source and destination addresses and an FCS to the segment.
- C. Packets are created when the network layer adds Layer 3 addresses and control information to a segment.
- D. Packets are created when the network layer encapsulates a frame with source and destination host addresses and protocol-related control information.
- E. The transport layer divides a data stream into segments and may add reliability and flow control information.

**Correct Answer:** CE

**Section:** (none)

**Explanation**

**Explanation/Reference:**

Explanation:

#### **QUESTION 27**

Which two statements about IPv4 multicast traffic are true? (Choose two.)

- A. It burdens the source host without affecting remote hosts.
- B. It uses a minimum amount of network bandwidth.
- C. It is bandwidth-intensive.
- D. It simultaneously delivers multiple streams of data.
- E. It is the most efficient way to deliver data to multiple receivers.



**Correct Answer:** DE  
**Section:** (none)  
**Explanation**

**Explanation/Reference:**  
Explanation:

**QUESTION 28**  
Refer to the exhibit.

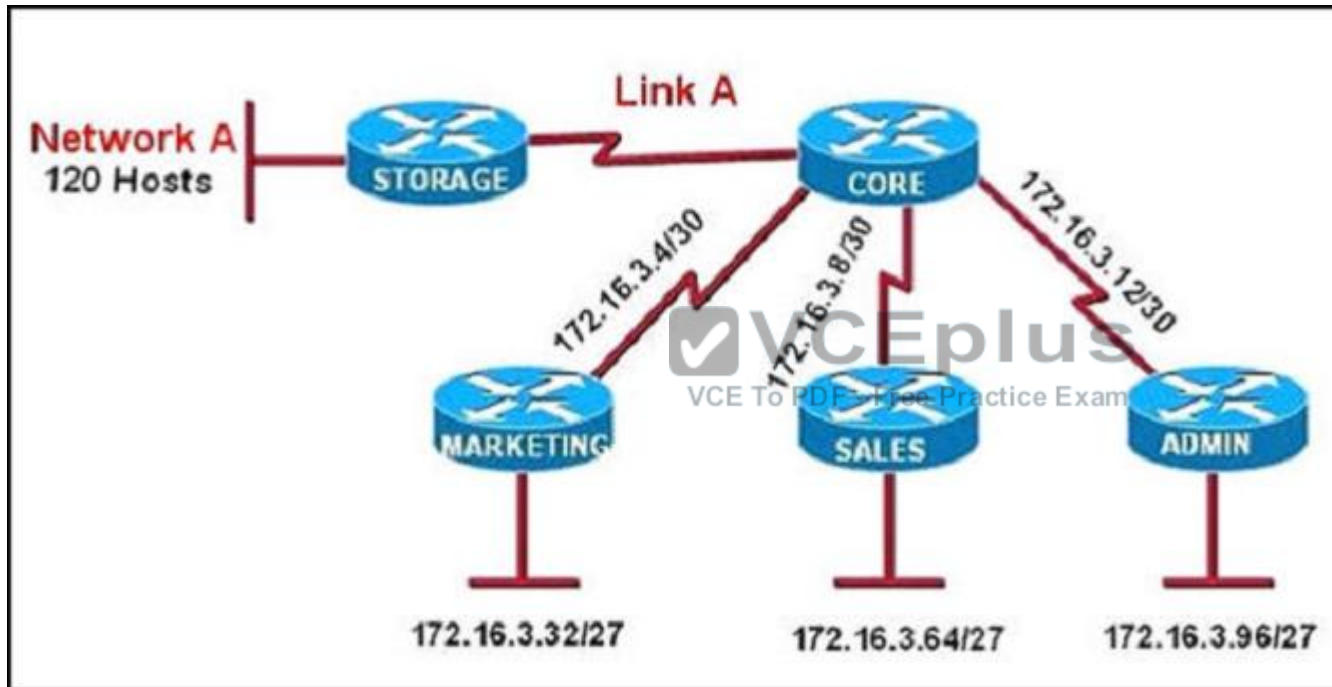

All of the routers in the network are configured with the ip subnet-zero command. Which network addresses should be used for Link A and Network A? (Choose two.)

- A. Link A – 172.16.3.0/30
- B. Link A – 172.16.3.112/30
- C. Network A – 172.16.3.48/26
- D. Network A – 172.16.3.128/25
- E. Link A – 172.16.3.40/30

F. Network A – 172.16.3.192/26

**Correct Answer:** AD

**Section:** (none)

**Explanation**

**Explanation/Reference:**

Explanation:

**QUESTION 29**

Which type of device can be replaced by the use of subinterfaces for VLAN routing?

- A. Layer 2 bridge
- B. Layer 2 switch
- C. Layer 3 switch
- D. router

**Correct Answer:** C

**Section:** (none)

**Explanation**

**Explanation/Reference:**

Explanation:



**QUESTION 30**

Which Layer 2 protocol encapsulation type supports synchronous and asynchronous circuits and has built-in security mechanisms?

- A. X.25
- B. HDLC
- C. PPP
- D. Frame Relay

**Correct Answer:** C

**Section:** (none)

**Explanation**

**Explanation/Reference:**

Explanation:

**QUESTION 31**

Which statement about LLDP is true?

- A. It is a Cisco proprietary protocol.
- B. It is configured in global configuration mode.
- C. The LLDP update frequency is a fixed value.
- D. It runs over the transport layer.

**Correct Answer:** B

**Section:** (none)

**Explanation**

**Explanation/Reference:**

Explanation:

### QUESTION 32

What are two benefits of private IPv4 IP addresses? (Choose two.)

- A. They are routed the same as public IP addresses.
- B. They are less costly than public IP addresses.
- C. They can be assigned to devices without Internet connections.
- D. They eliminate the necessity for NAT policies.
- E. They eliminate duplicate IP conflicts.



**Correct Answer:** BC

**Section:** (none)

**Explanation**

**Explanation/Reference:**

Explanation:

### QUESTION 33

If the primary root bridge experiences a power loss, which switch takes over?

- A. switch 0040.0 0.90C5
- B. switch 00E0.F90B.6BE3
- C. switch 0004.9A1A.C182
- D. switch 00E0.F726.3DC6

**Correct Answer:** C

**Section:** (none)

**Explanation**

**Explanation/Reference:**

Explanation:

**QUESTION 34**

A network administrator is troubleshooting an EIGRP problem on a router and needs to confirm the IP addresses of the devices with which the router has established adjacency. The retransmit interval and the queue counts for the adjacent routers also need to be checked. What command will display the required information?

- A. Router# show ip eigrp neighbors
- B. Router# show ip eigrp interfaces
- C. Router# show ip eigrp adjacency
- D. Router# show ip eigrp topology

**Correct Answer:** A

**Section:** (none)

**Explanation**

**Explanation/Reference:**

Explanation:

**QUESTION 35**

What is the authoritative source for an address lookup?

- A. a recursive DNS search
- B. the operating system cache
- C. the ISP local cache
- D. the browser cache

**Correct Answer:** A

**Section:** (none)

**Explanation**

**Explanation/Reference:**

Explanation:

**QUESTION 36**

Which command can you enter to verify that a BGP connection to a remote device is established?

- A. show ip bgp summary
- B. show ip community-list

- C. show ip bgp paths
- D. show ip route

**Correct Answer:** A

**Section:** (none)

**Explanation**

**Explanation/Reference:**

Explanation:

**QUESTION 37**

Refer to the exhibit.

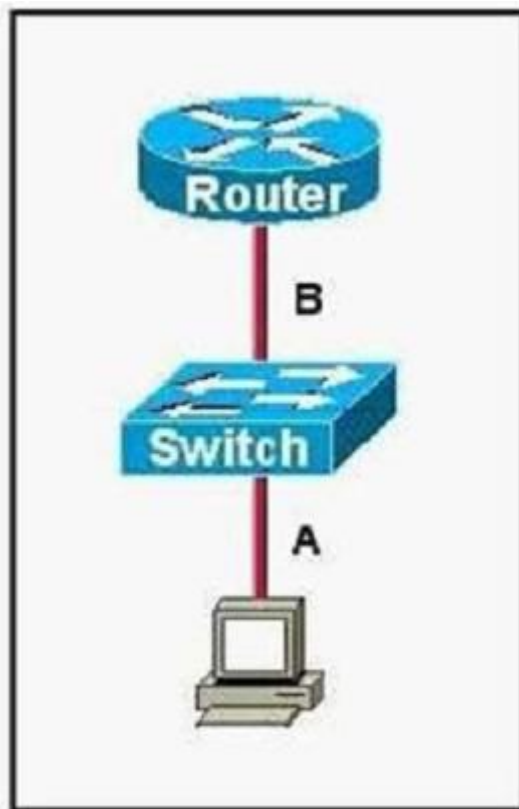

The two connected ports on the switch are not turning orange or green. Which three would be the most effective steps to troubleshoot this physical layer

problem? (Choose three.)

- A. Ensure the switch has power.
- B. Reseat all cables.
- C. Ensure cable A is plugged into a trunk port.
- D. Ensure that the Ethernet encapsulations match on the interconnected router and switch ports.
- E. Reboot all of the devices.
- F. Ensure that cables A and are straight-through cables.

**Correct Answer:** ABF

**Section:** (none)

**Explanation**

**Explanation/Reference:**

Explanation:

#### **QUESTION 38**

During which phase of PPPoE is PPP authentication performed?

- A. the PPP Session phase
- B. Phase 2
- C. the Active Discovery phase
- D. the Authentication phase
- E. Phase 1



**Correct Answer:** A

**Section:** (none)

**Explanation**

**Explanation/Reference:**

Explanation:

#### **QUESTION 39**

Which three circumstances can cause a GRE tunnel to be in an up/down state? (Choose three.)

- A. The tunnel interface IP address is misconfigured.
- B. The tunnel interface is down.
- C. A valid route to the destination address is missing from the routing table.
- D. The tunnel address is routed through the tunnel itself.

- E. The ISP is blocking the traffic.
- F. An ACL is blocking the outbound traffic.

**Correct Answer:** BCD

**Section:** (none)

**Explanation**

**Explanation/Reference:**

Explanation:

#### QUESTION 40

Which three statements about IPv6 prefixes are true? (Choose three.)

- A. FEC0::/10 is used for IPv6 broadcast.
- B. FC00::/7 is used in private networks.
- C. FE80::/8 is used for link-local unicast.
- D. FE80::/10 is used for link-local unicast.
- E. 2001::1/127 is used for loopback addresses.
- F. FF00::/8 is used for IPv6 multicast.

**Correct Answer:** BDF

**Section:** (none)

**Explanation**

**Explanation/Reference:**

Explanation:

#### QUESTION 41

Which command can you enter to display duplicate IP addresses that the DHCP server assigns?

- A. show ip dhcp conflict 10.0.2.12
- B. show ip dhcp database 10.0.2.12
- C. show ip dhcp server statistics
- D. show ip dhcp binding 10.0.2.12

**Correct Answer:** A

**Section:** (none)

**Explanation**

**Explanation/Reference:**

Explanation:

**QUESTION 42**

Refer to the exhibit.

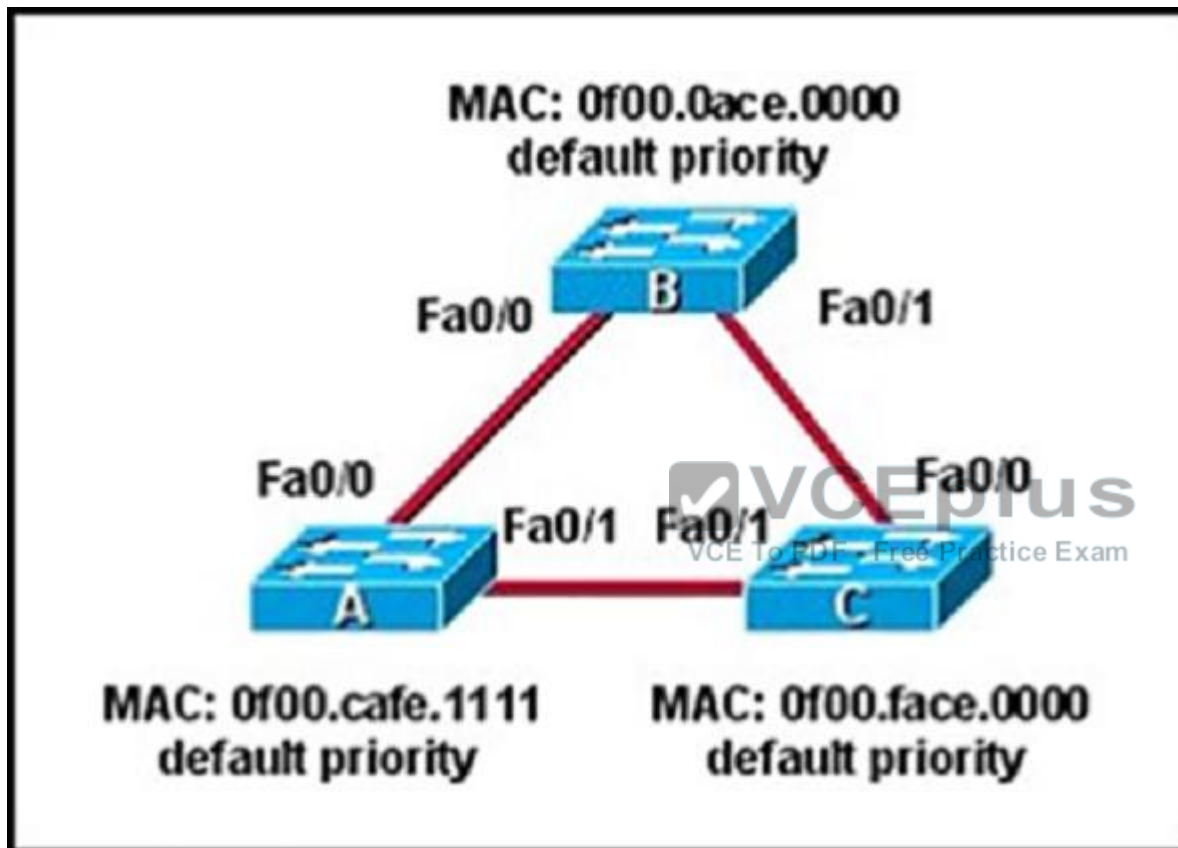

Which three ports will be STP designated ports if all the links are operating at the same bandwidth? (Choose three.)

- A. Switch B - F 0/0
- B. Switch A - Fa0/1
- C. Switch - Fa0/1
- D. Switch - F 0/1
- E. Switch A - Fa0/0



F. Switch - Fa0/0

**Correct Answer:** ABC

**Section:** (none)

**Explanation**

**Explanation/Reference:**

Explanation:

#### **QUESTION 43**

Which two statements about using leased lines for your WAN infrastructure are true? (Choose two.)

- A. Leased lines provide inexpensive WAN access.
- B. Leased lines with sufficient bandwidth can avoid latency between endpoints.
- C. Leased lines require little installation and maintenance expertise.
- D. Leased lines provide highly flexible bandwidth scaling.
- E. Multiple leased lines can share a router interface.
- F. Leased lines support up to T1 link speeds.

**Correct Answer:** CD

**Section:** (none)

**Explanation**

**Explanation/Reference:**

Explanation:

#### **QUESTION 44**

Refer to the exhibit.

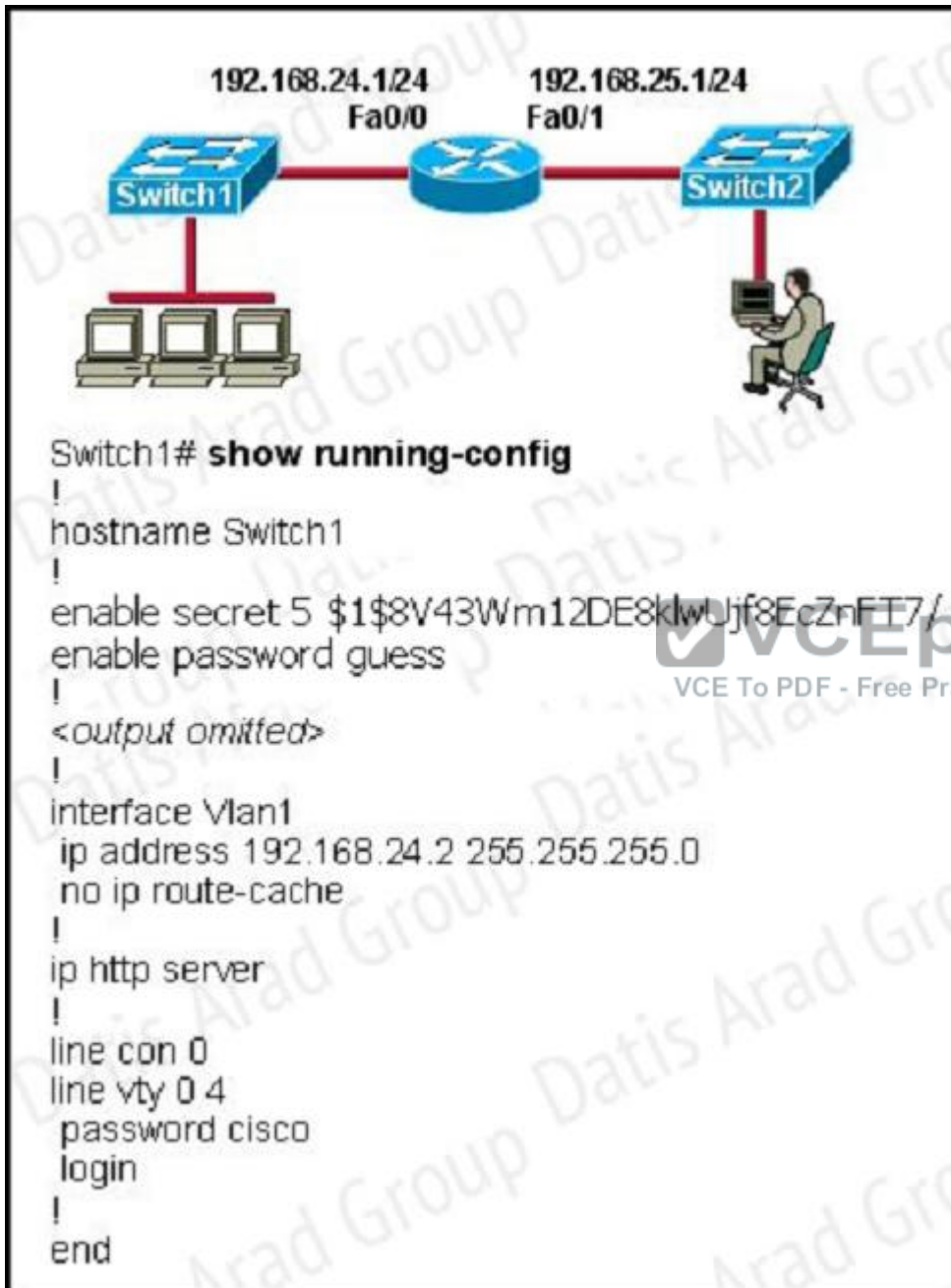

The network administrator cannot connect to Switch 1 over a Telnet session, although the hosts attached to Switch1 can ping the interface Fa0/0 of the router. Given the information in the graphic and assuming that the router and Switch2 are configured properly, which of the following commands should be issued on Switch1 to correct this problem?

- A. Switch1(config)# ip default-gateway 192.168.24.1
- B. Switch1(config)# interface fa0/1Switch1(config-if)# switchport mode trunk
- C. Switch1(config)# line con0Switch1(config-line)# password ciscoSwitch1(config-line)# login
- D. Switch1(config)# interface fa0/1Switch1(config-if)# ip address 192.168.24.3 255.255.255.0
- E. Switch1(config)# interface fa0/1Switch1(config-if)# duplex fullSwitch1(config-if)# speed 100

**Correct Answer:** A

**Section:** (none)

**Explanation**

**Explanation/Reference:**

Explanation:

#### QUESTION 45

Which two statements about IPv6 and routing protocols are true? (Choose two.)

- A. EIGRPv3 was developed to support IPv6 routing.
- B. OSPFv3 was developed to support IPv6 routing.
- C. Loopback addresses are used to form routing adjacencies.
- D. EIGRP, OSPF, and BGP are the only routing protocols that support IPv6.
- E. Link-local addresses are used to form routing adjacencies.

**Correct Answer:** BE

**Section:** (none)

**Explanation**

**Explanation/Reference:**

Explanation:

#### QUESTION 46

Refer to the exhibit.

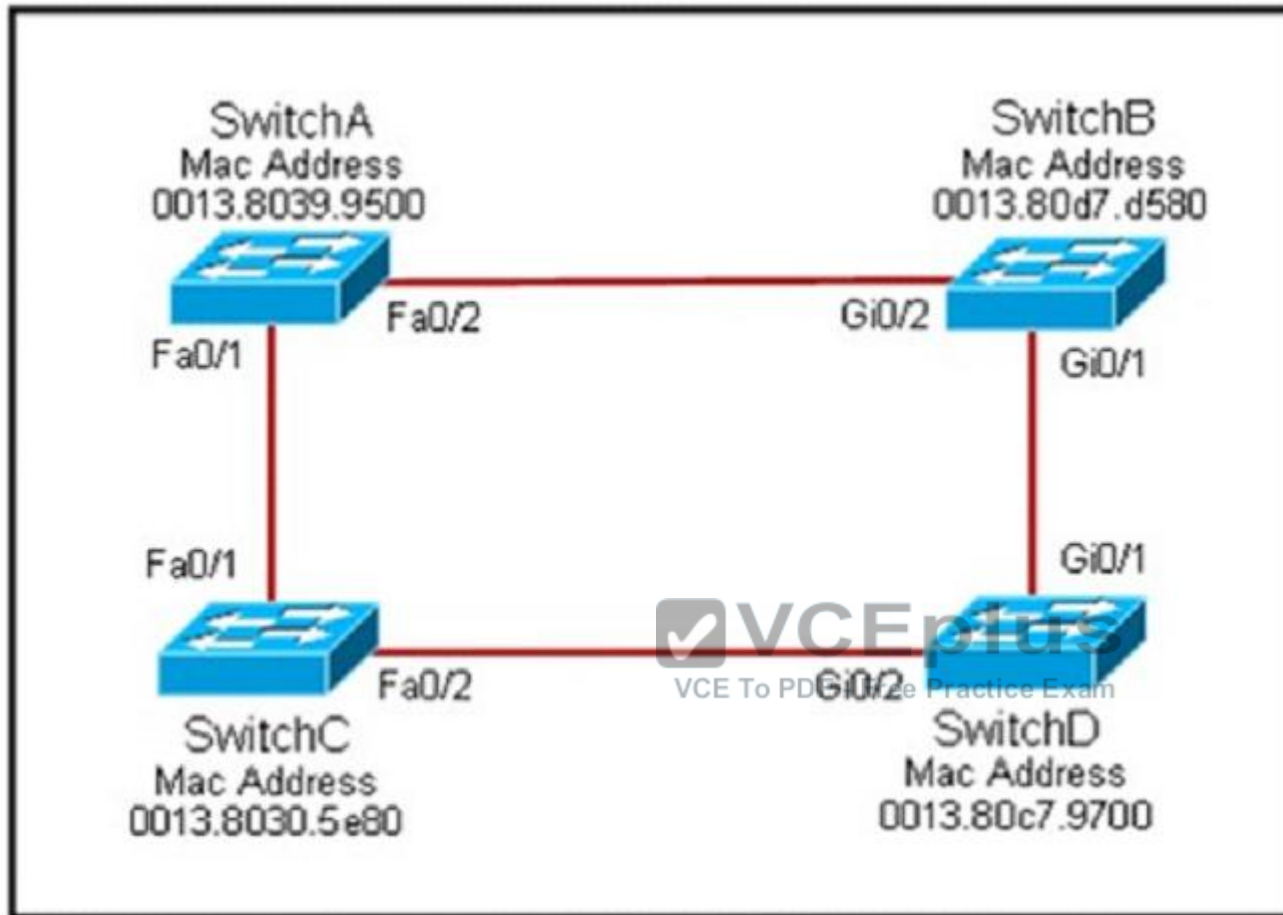

Each of these four switches has been configured with a hostname, as well as being configured to run RSTP. No other configuration changes have been made. Which three of these show the correct RSTP port roles for the indicated switches and interfaces? (Choose three.)

- A. SwitchD, Gi0/2, root
- B. SwitchA, Fa0/2, designated
- C. SwitchB, Gi0/1, designated
- D. SwitchA, Fa0/1, root
- E. SwitchB, Gi0/2, root
- F. SwitchC, Fa0/2, root

**Correct Answer:** ABD

**Section:** (none)

**Explanation**

**Explanation/Reference:**

Explanation:

**QUESTION 47**

Which feature builds a FIB and an adjacency table to expedite packet forwarding?

- A. cut through
- B. fast switching
- C. process switching
- D. Cisco Express Forwarding

**Correct Answer:** D

**Section:** (none)

**Explanation**

**Explanation/Reference:**

Explanation:



**QUESTION 48**

Which command can you enter to verify that a 128-bit address is live and responding?

- A. traceroute
- B. telnet
- C. ping
- D. ping ipv6

**Correct Answer:** D

**Section:** (none)

**Explanation**

**Explanation/Reference:**

Explanation:

**QUESTION 49**

What will happen if a private IP address is assigned to a public interface connected to an ISP?

- A. A conflict of IP addresses happens, because other public routers can use the same range.
- B. Addresses in a private range will not be routed on the Internet backbone.
- C. Only the ISP router will have the capability to access the public network.
- D. The NAT process will be used to translate this address to a valid IP address.

**Correct Answer:** B

**Section:** (none)

**Explanation**

**Explanation/Reference:**

Explanation:

#### **QUESTION 50**

DRAG DROP

PC\_1 is sending packets to the FTP server. Consider the packets as they leave RouterA interface Fa0/0 towards RouterB. Drag the correct frame and packet address to their place in the table.

**Select and Place:**

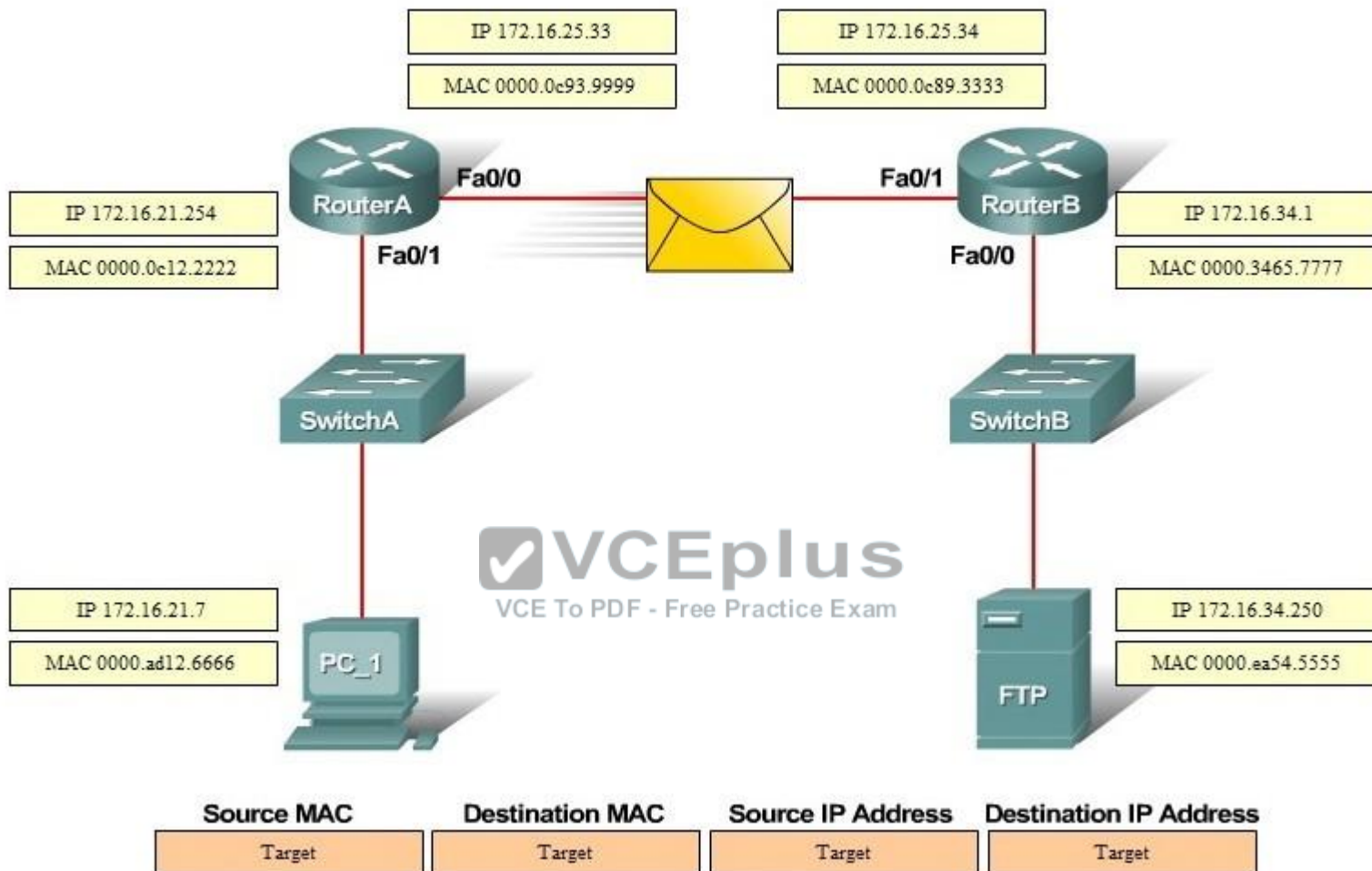

**Correct Answer:**

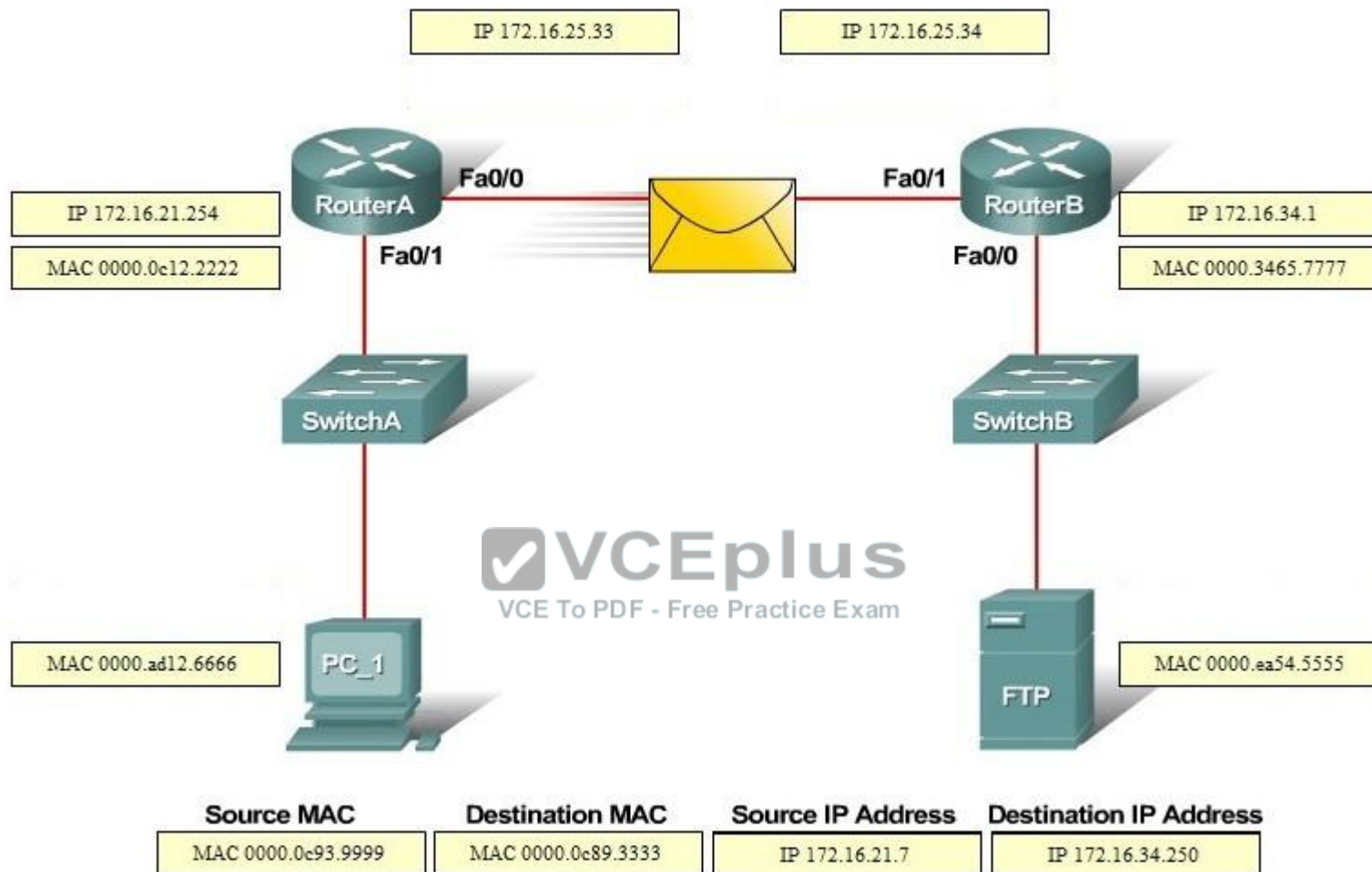

Section: (none)  
Explanation

Explanation/Reference:

**QUESTION 51**

What are two reasons that duplex mismatches can be difficult to diagnose? (Choose two.)



- A. The interface displays a connected (up/up) state even when the duplex settings are mismatched.
- B. 1-Gbps interfaces are full-duplex by default.
- C. Full-duplex interfaces use CSMA/CD logic, so mismatches may be disguised by collisions.
- D. The symptoms of a duplex mismatch may be intermittent.
- E. Autonegotiation is disabled.

**Correct Answer:** AD

**Section:** (none)

**Explanation**

**Explanation/Reference:**

Explanation:

#### **QUESTION 52**

Which condition indicates that service password-encryption is enabled?

- A. The local username password is in clear text in the configuration.
- B. The enable secret is in clear text in the configuration.
- C. The local username password is encrypted in the configuration.
- D. The enable secret is encrypted in the configuration.



**Correct Answer:** C

**Section:** (none)

**Explanation**

**Explanation/Reference:**

Explanation:

#### **QUESTION 53**

Which command would you configure globally on a Cisco router that would allow you to view directly connected Cisco devices?

- A. cdp run
- B. enable cdp
- C. cdp enable
- D. run cdp

**Correct Answer:** A

**Section:** (none)

**Explanation**

**Explanation/Reference:**

Explanation:

**QUESTION 54**

Which two statements about wireless LAN controllers are true? (Choose two.)

- A. They can simplify the management and deployment of wireless LANs.
- B. They rely on external firewalls for WLAN security.
- C. They are best suited to smaller wireless networks.
- D. They must be configured through a GUI over HTTP or HTTPS.
- E. They can manage mobility policies at a systemwide level.

**Correct Answer:** AE

**Section:** (none)

**Explanation**

**Explanation/Reference:**

Explanation:

**QUESTION 55**

Which two statements about northbound and southbound APIs are true? (Choose two.)

- A. Only southbound APIs allow program control of the network.
- B. Only northbound APIs allow program control of the network.
- C. Only southbound API interfaces use a Service Abstraction Layer.
- D. Only northbound API interfaces use a Service Abstraction Layer.
- E. Both northbound and southbound API interfaces use a Service Abstraction Layer.
- F. Both northbound and southbound APIs allow program control of the network.

**Correct Answer:** BC

**Section:** (none)

**Explanation**

**Explanation/Reference:**

Explanation:

**QUESTION 56**

Which command can you enter to set the default route for all traffic to an interface?

- A. `router(config)#ip route 0.0.0.0 0.0.0.0 GigabitEthernet0/1`

- B. router(config-router)#default-information originate always
- C. router(config)#ip route 0.0.0.0 255.255.255.255 GigabitEthernet0/1
- D. route(config-router)#default-information originate

**Correct Answer:** A

**Section:** (none)

**Explanation**

**Explanation/Reference:**

Explanation:

#### **QUESTION 57**

Which step in the router boot process searches for an IOS image to load into the router?

- A. mini-IOS
- B. ROMMON mode
- C. bootstrap
- D. POST

**Correct Answer:** C

**Section:** (none)

**Explanation**

**Explanation/Reference:**

Explanation:

#### **QUESTION 58**

Which protocol advertises a virtual IP address to facilitate transparent failover of a Cisco routing device?

- A. FHRP
- B. DHCP
- C. RSMLT
- D. ESRP

**Correct Answer:** A

**Section:** (none)

**Explanation**

**Explanation/Reference:**

**QUESTION 59**

Scenario

Refer to the topology. Your company has decided to connect the main office with three other remote branch offices using point-to-point serial links.

You are required to troubleshoot and resolve OSPF neighbor adjacency issues between the main office and the routers located in the remote branch offices.

Use appropriate show commands to troubleshoot the issues and answer all four questions.

Instructions

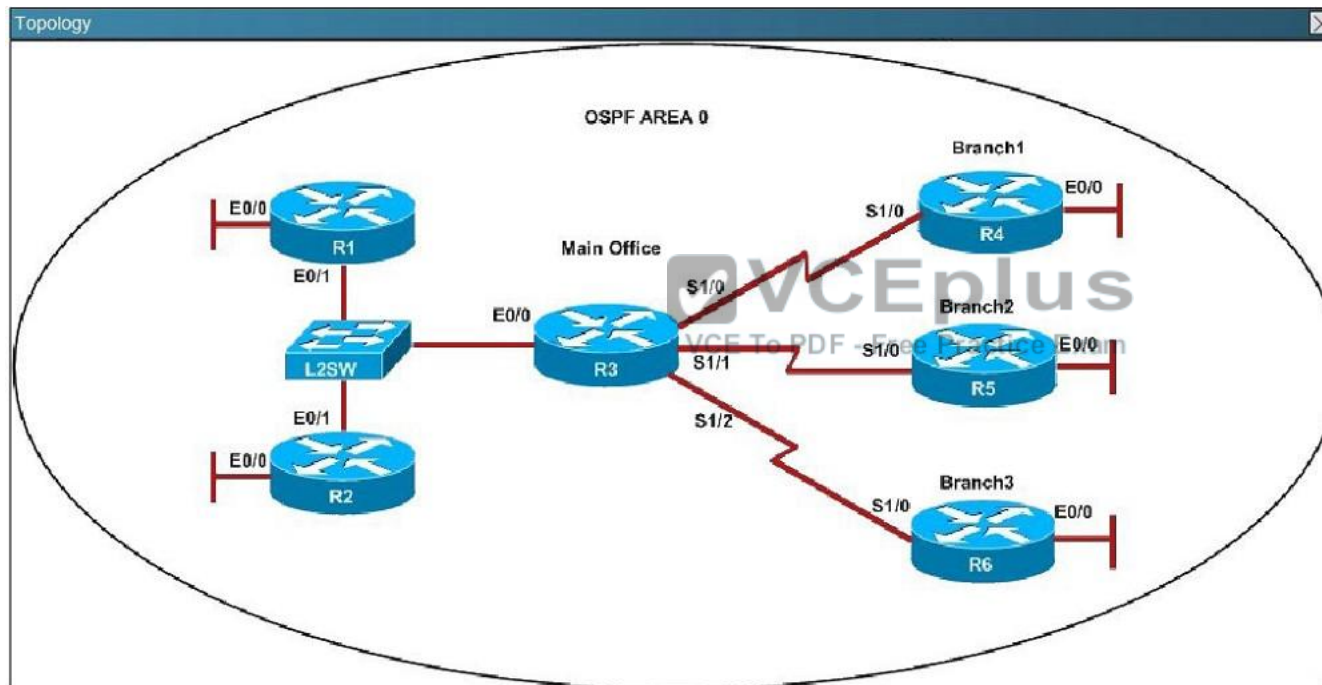

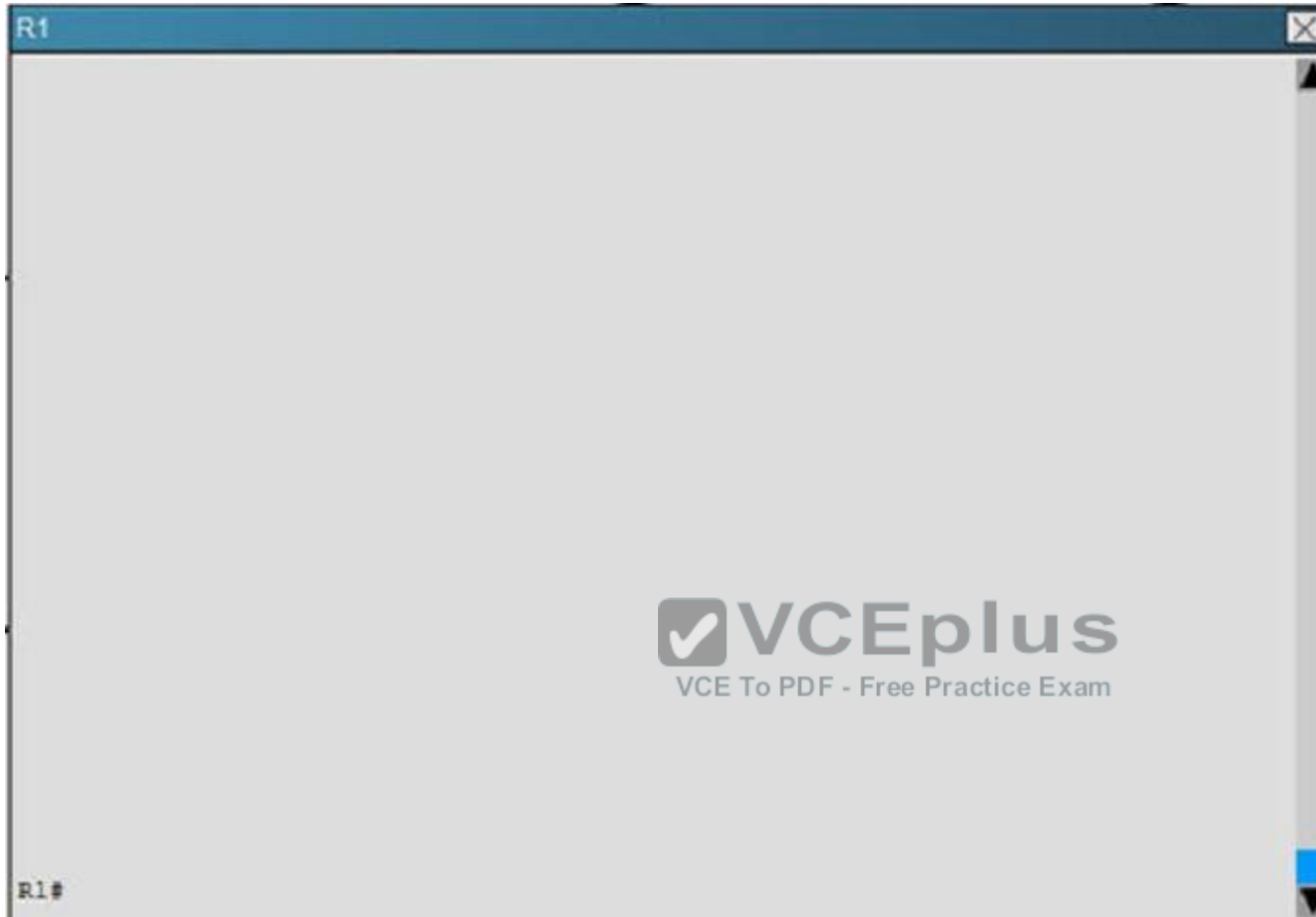

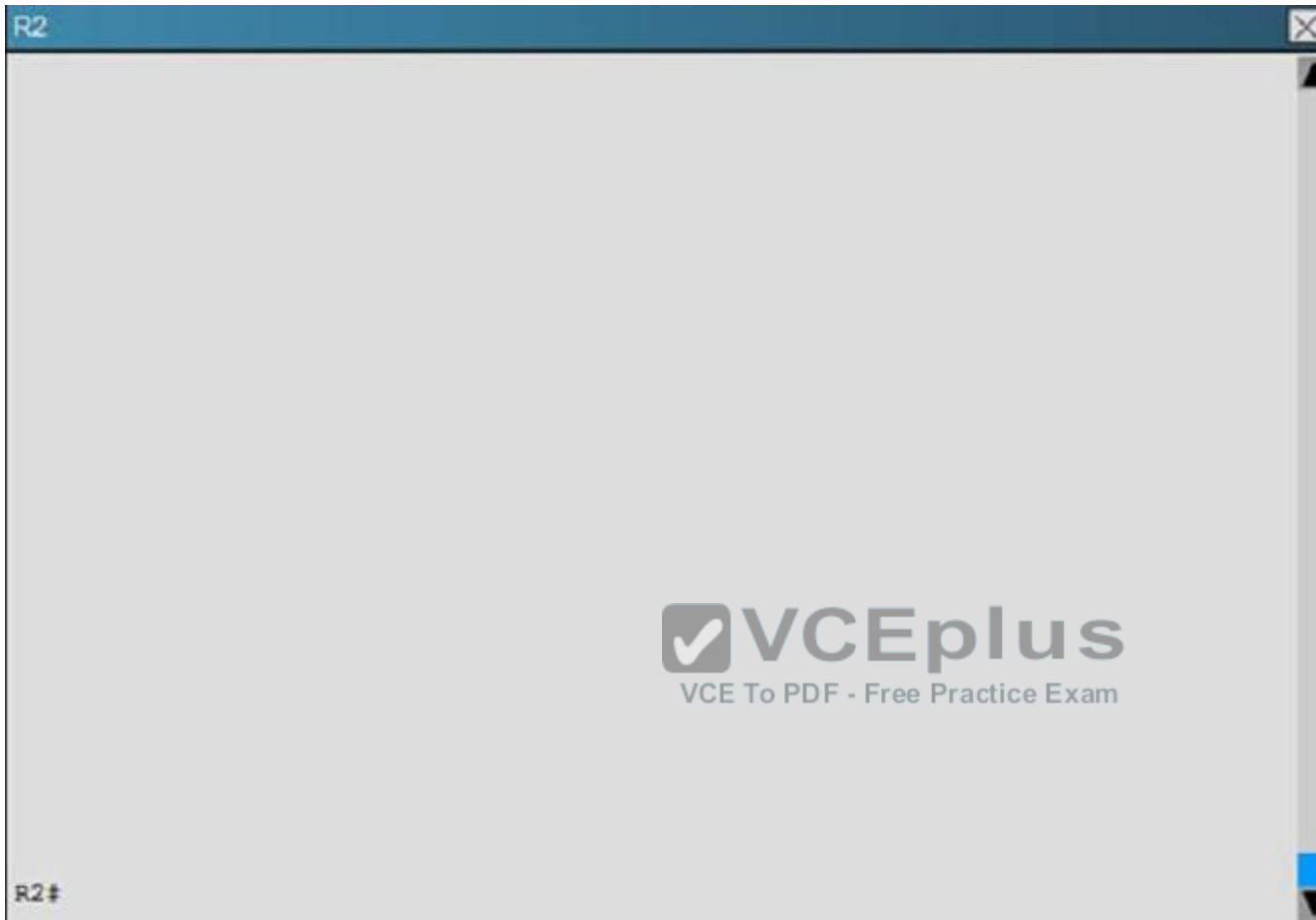

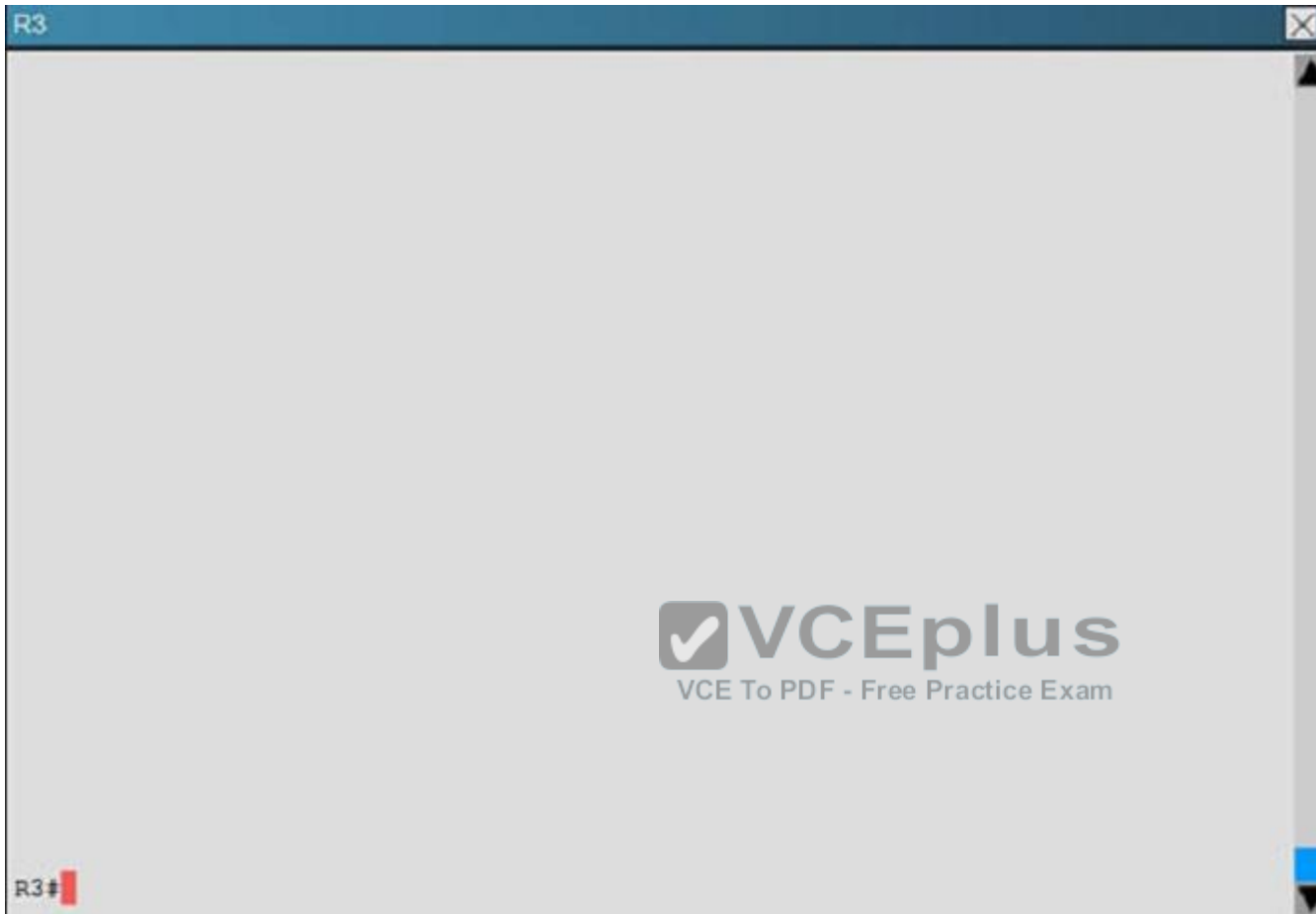

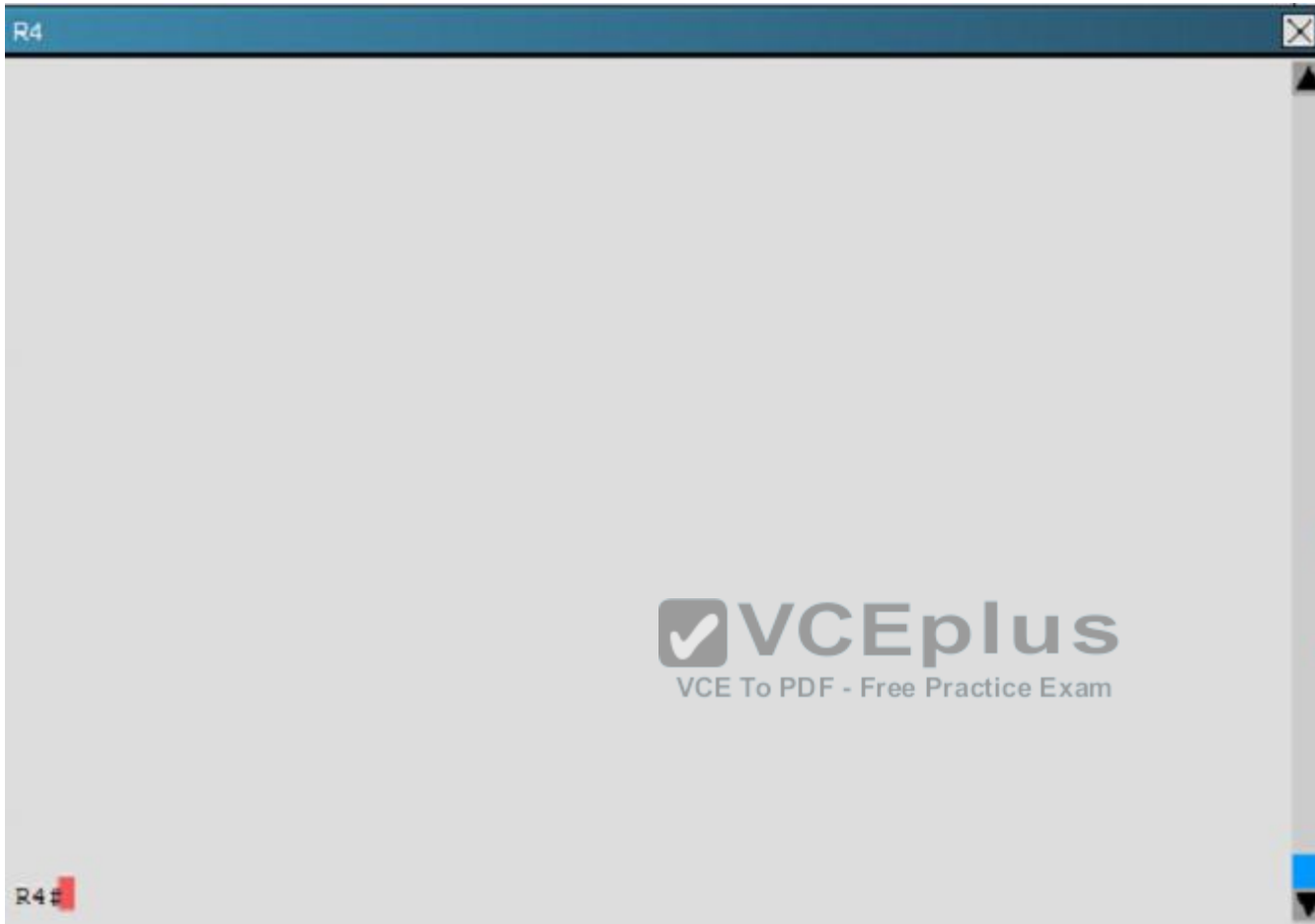



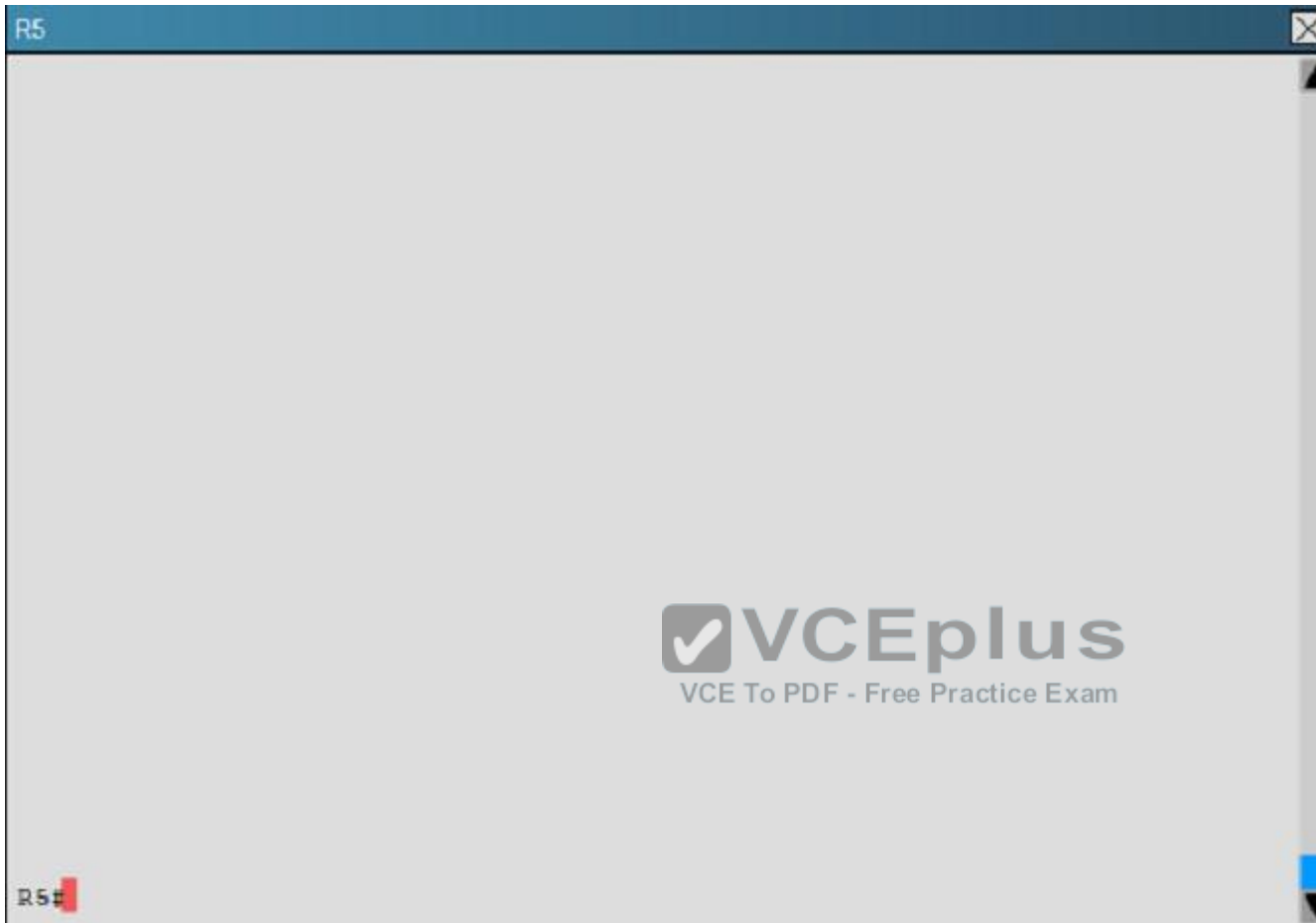



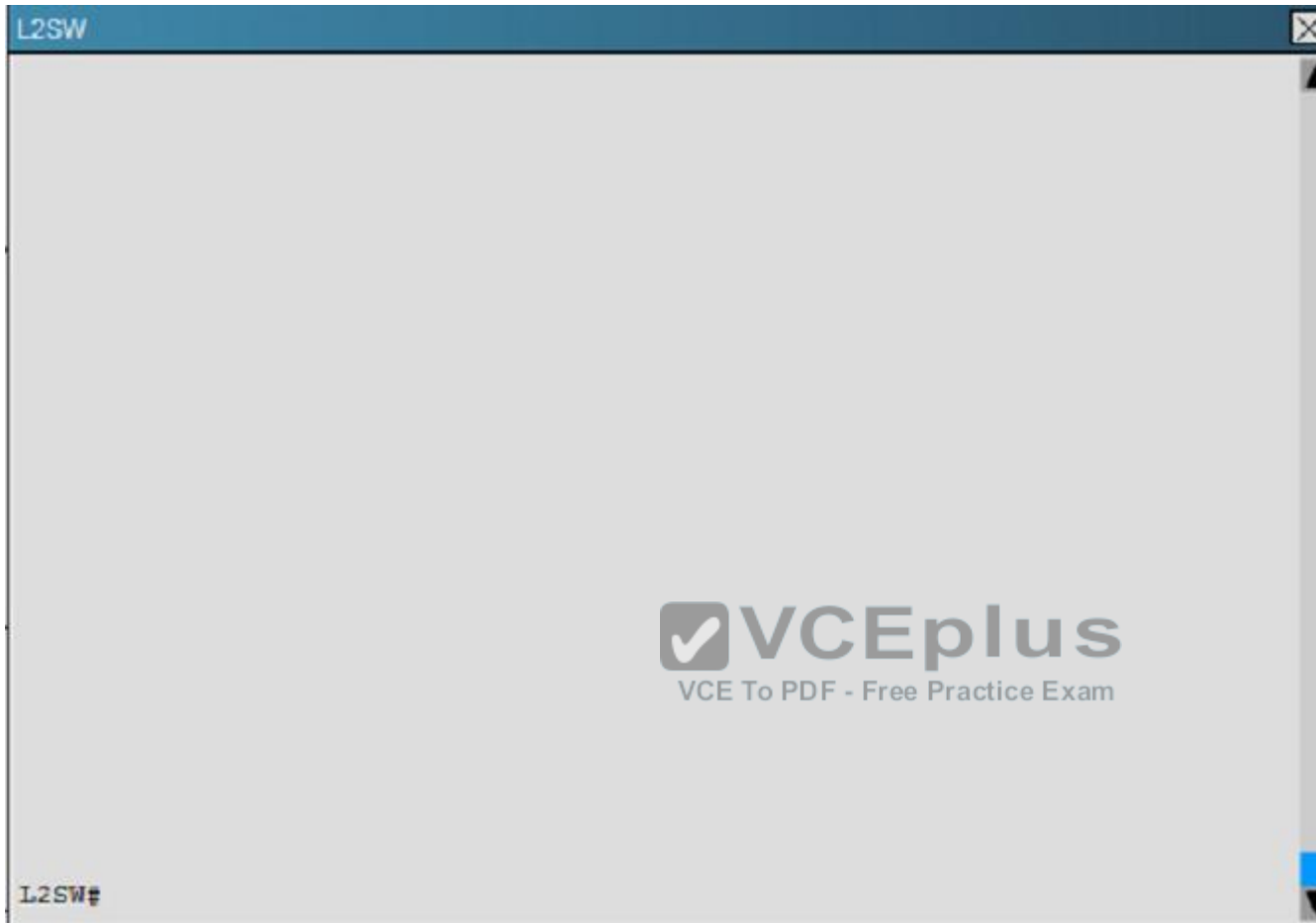

An OSPF neighbor adjacency is not formed between R3 in the main office and R4 in the Branch1 office. What is causing the problem?

- A. There is an area ID mismatch.
- B. There is a Layer 2 issue; an encapsulation mismatch on serial links.
- C. There is an OSPF hello and dead interval mismatch.
- D. The R3 router ID is configured on R4.

**Correct Answer:** A

**Section:** (none)

**Explanation**

**Explanation/Reference:**

Explanation:

Here are the relevant parts of the router configs:

```
R1interface Loopback0description ***Loopback***ip address 192.168.1.1 255.255.255.255ip ospf 1 area 0!interface Ethernet0/0description **Connected to R1-LAN**ip address 10.10.110.1 255.255.255.0ip ospf 1 area 0!interface Ethernet0/1description **Connected to L2SW**ip address 10.10.230.1 255.255.255.0ip ospf hello-interval 25ip ospf 1 area 0!router ospf 1log-adjacency-changes
R2!interface Loopback0description **Loopback**ip address 192.168.2.2 255.255.255.255ip ospf 2 area 0!interface Ethernet0/0description **Connected to R2-LAN**ip address 10.10.120.1 255.255.255.0ip ospf 2 area 0!interface Ethernet0/1description **Connected to L2SW**ip address 10.10.230.2 255.255.255.0ip ospf 2 area 0!router ospf 2log-adjacency-changes
R3username R6 password CISCO36!interface Loopback0description **Loopback**ip address 192.168.3.3 255.255.255.255ip ospf 3 area 0!interface Ethernet0/0description **Connected to L2SW**ip address 10.10.230.3 255.255.255.0ip ospf 3 area 0!interface Serial1/0description **Connected to R4-Branch1 office**ip address 10.10.240.1 255.255.255.252encapsulation pppip ospf 3 area 0!interface Serial1/1description **Connected to R5-Branch2 office**ip address 10.10.240.5 255.255.255.252encapsulation pppip ospf hello-interval 50ip ospf 3 area 0!interface Serial1/2description **Connected to R6-Branch3 office**ip address 10.10.240.9 255.255.255.252encapsulation pppip ospf 3 area 0ppp authentication chap!router ospf 3router-id 192.168.3.3!
R4!interface Loopback0description **Loopback**ip address 192.168.4.4 255.255.255.255ip ospf 4 area 2!interface Ethernet0/0ip address 172.16.113.1 255.255.255.0ip ospf 4 area 2!interface Serial1/0description **Connected to R3-Main Branch office**ip address 10.10.240.2 255.255.255.252encapsulation pppip ospf 4 area 2!router ospf 4log-adjacency-changes
R5!interface Loopback0description **Loopback**ip address 192.168.5.5 255.255.255.255ip ospf 5 area 0!interface Ethernet0/0ip address 172.16.114.1 255.255.255.0ip ospf 5 area 0!interface Serial1/0description **Connected to R3-Main Branch office**ip address 10.10.240.6 255.255.255.252encapsulation pppip ospf 5 area 0!router ospf 5log-adjacency-changes
R6username R3 password CISCO36!interface Loopback0description **Loopback**ip address 192.168.6.6 255.255.255.255ip ospf 6 area 0!interface Ethernet0/0ip address 172.16.115.1 255.255.255.0ip ospf 6 area 0!interface Serial1/0description **Connected to R3-Main Branch office**ip address 10.10.240.10 255.255.255.252encapsulation pppip ospf 6 area 0ppp authentication chap!router ospf 6router-id 192.168.3.3!
```

On both R3 and R4 use “show running-config” command to check their S1/0 interfaces

```
R3#show running-config<<output omitted>>!interface Serial1/0description **Connected to R4-Branch1 office**ip address 10.10.240.1 255.255.255.252encapsulation pppip ospf 3 area 0!<<output omitted>>
```

```
R4#show running-config<<output omitted>>!interface Serial1/0description **Connected to R3-Main Branch office**ip address 10.10.240.2 255.255.255.252encapsulation pppip ospf 4 area 2!<<output omitted>>
```

In the output above we see their Area IDs are mismatched; interface S1/0 of R3 is in area 0 (R3: ip ospf 3 area 0) while interface s1/0 of R4 is in area 2 (R4: ip ospf 4 area 2).

**QUESTION 60**

Scenario

Refer to the topology. Your company has decided to connect the main office with three other remote branch offices using point-to-point serial links.

You are required to troubleshoot and resolve OSPF neighbor adjacency issues between the main office and the routers located in the remote branch offices.

Use appropriate show commands to troubleshoot the issues and answer all four questions.

Instructions

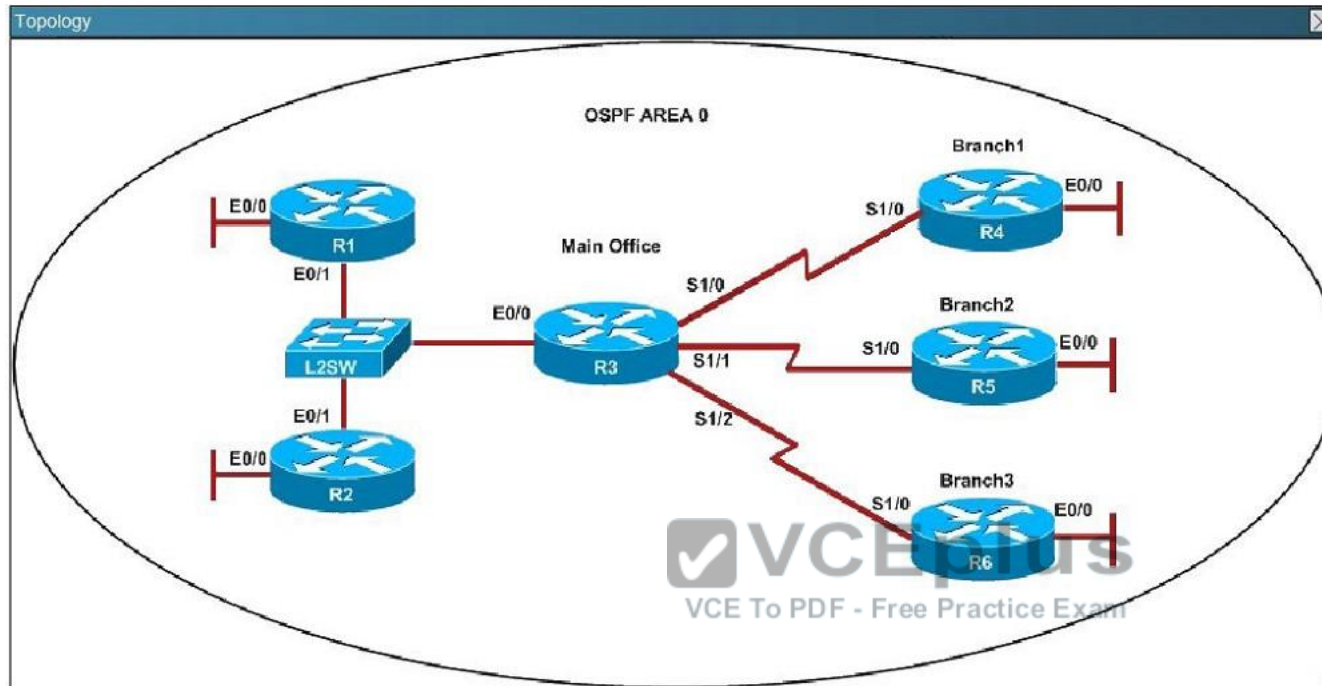

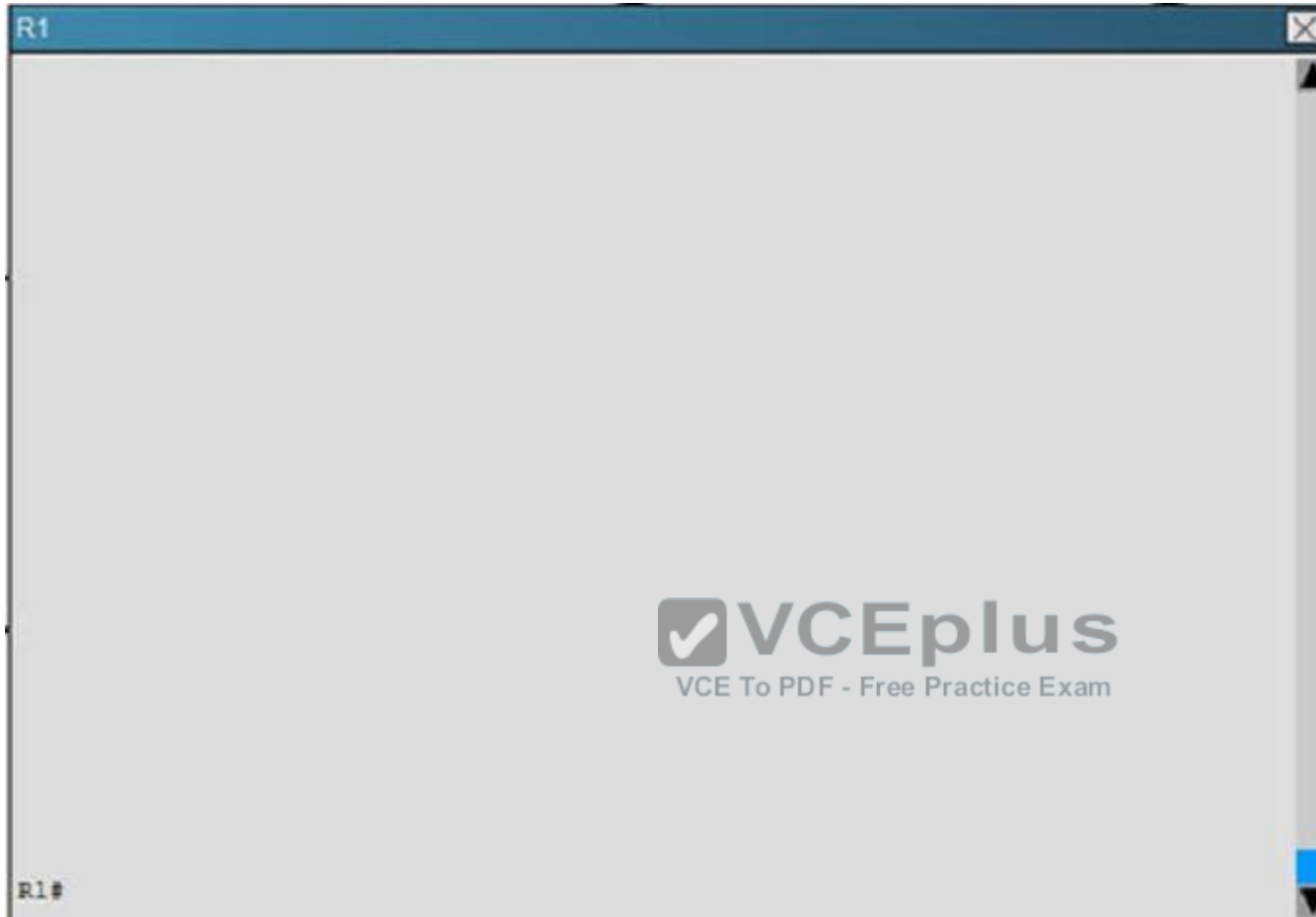

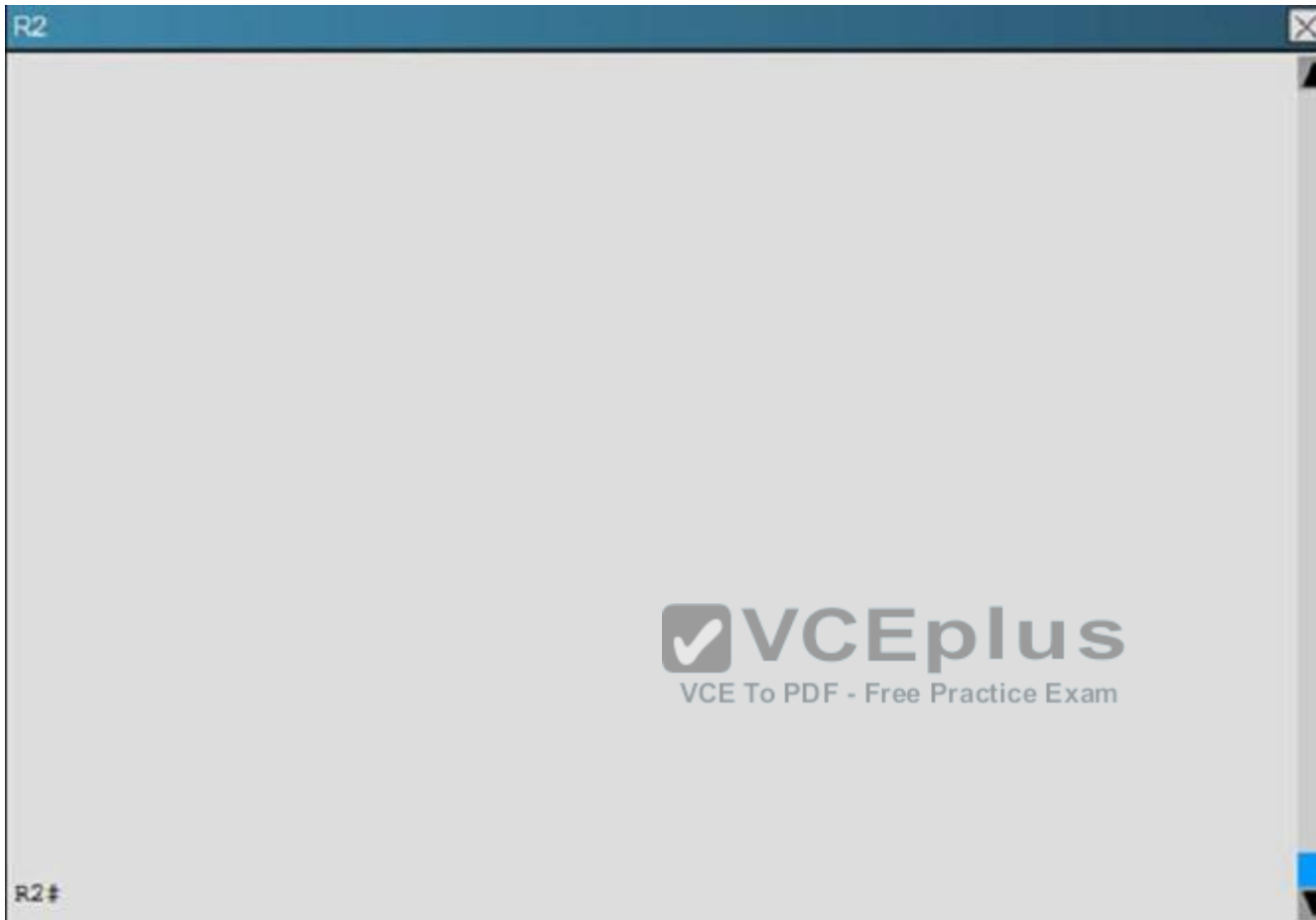

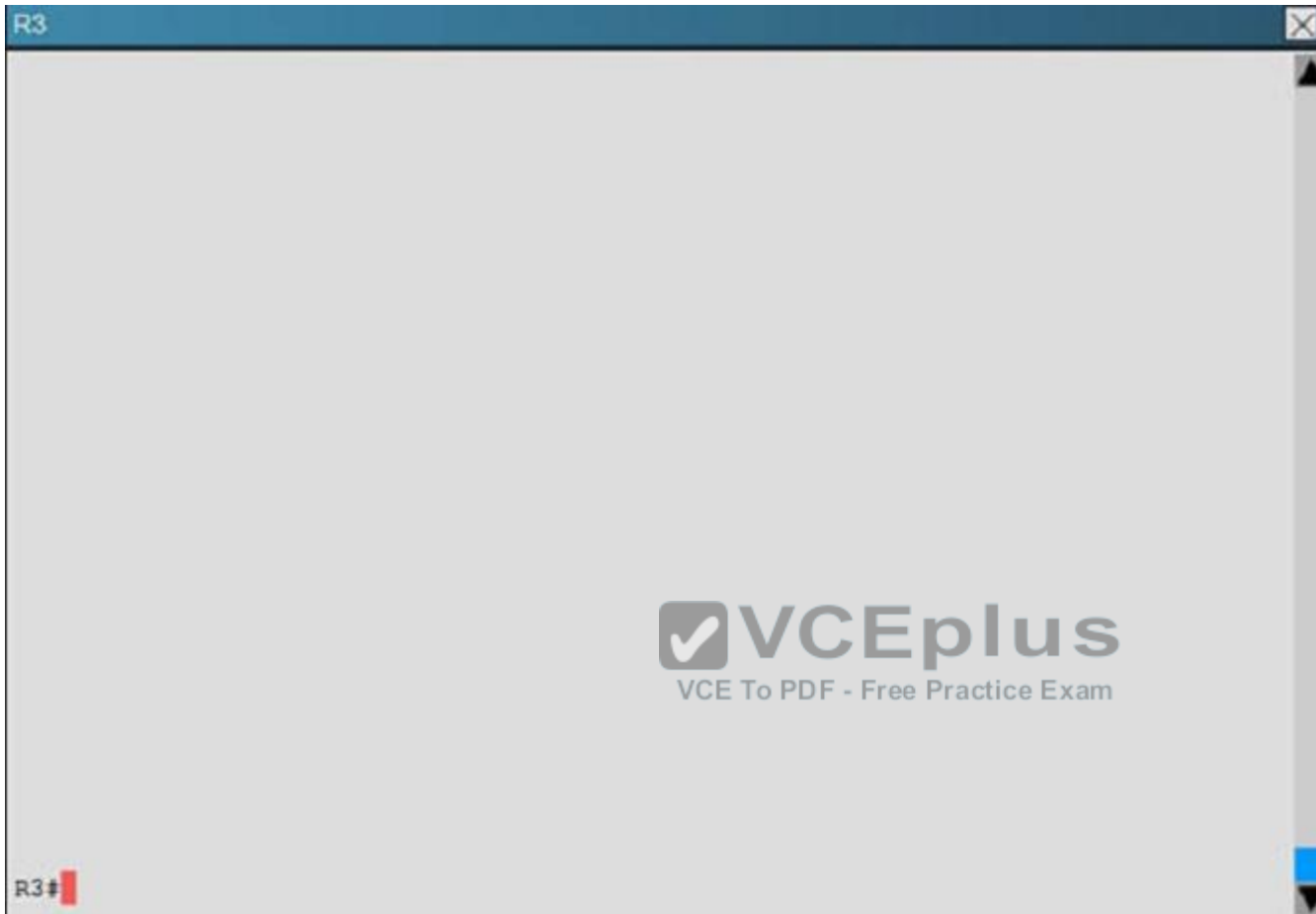



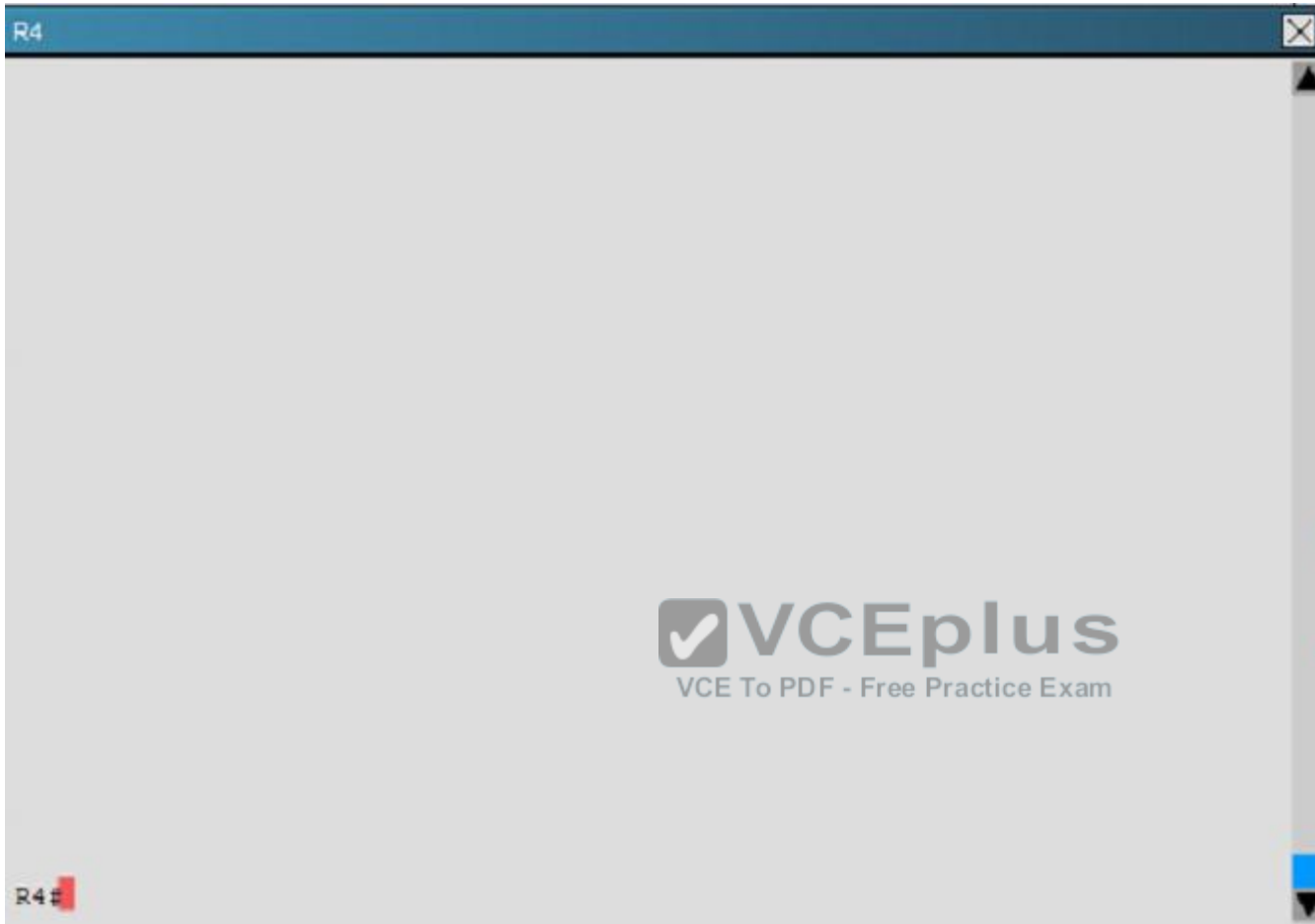

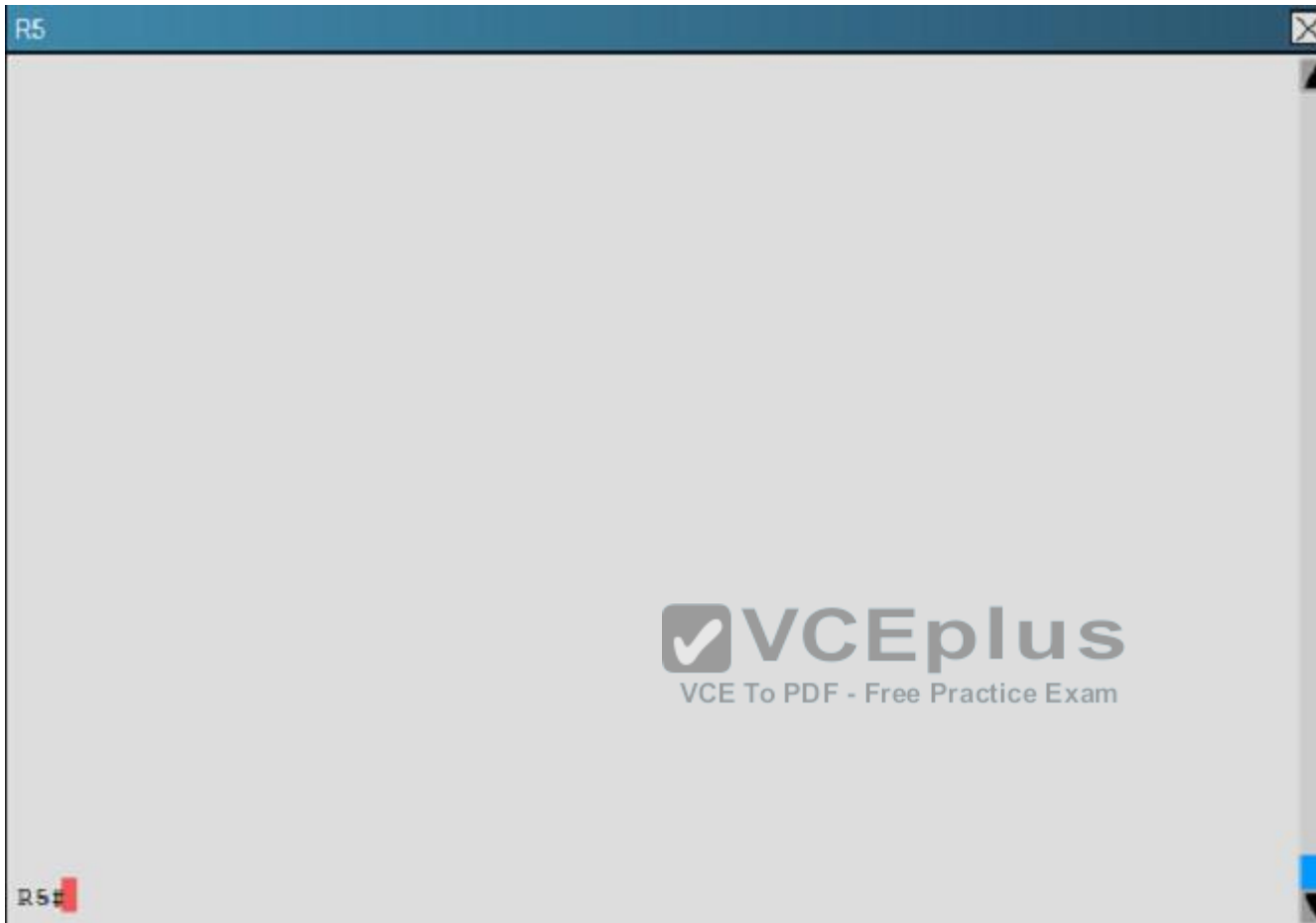



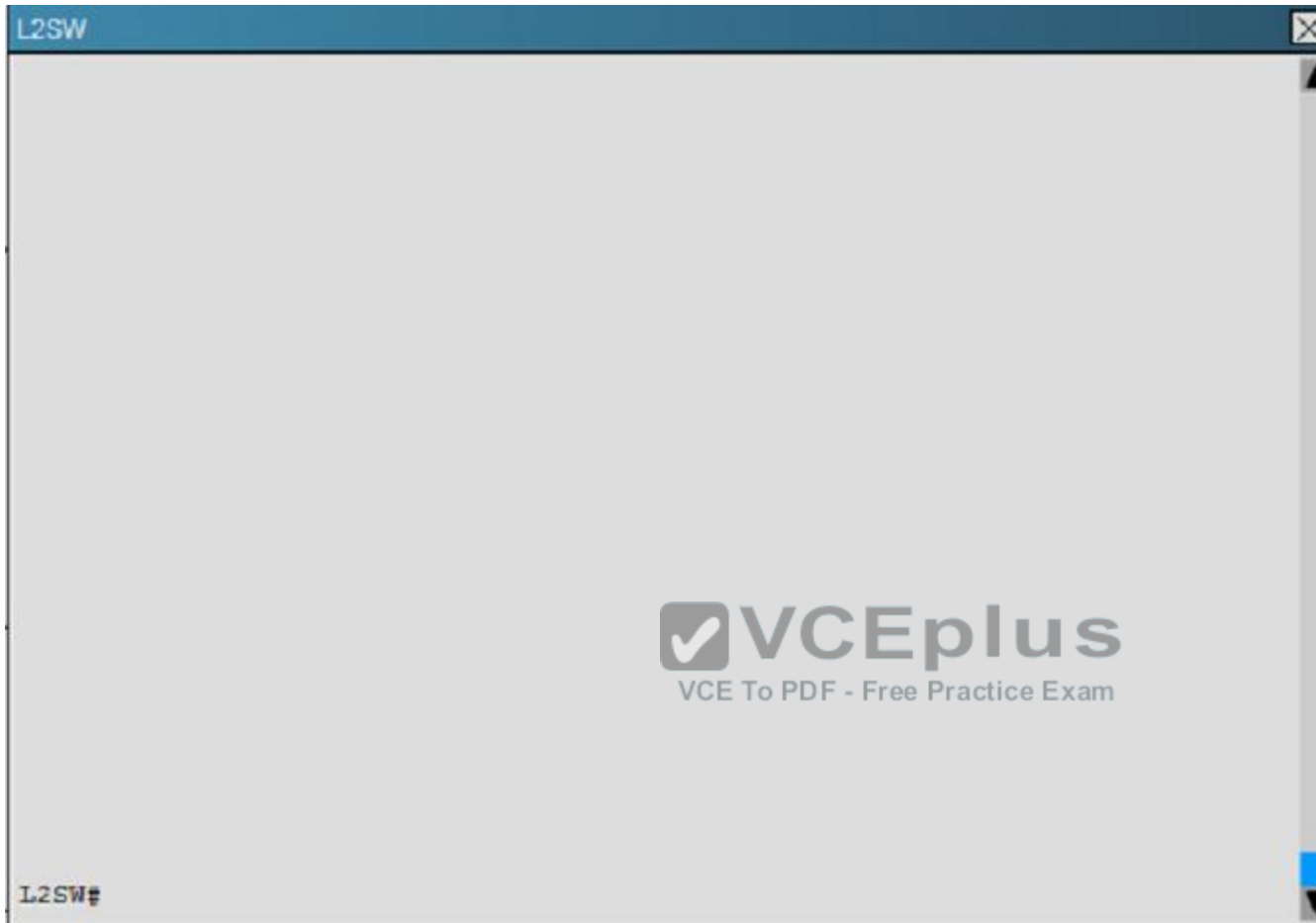

An OSPF neighbor adjacency is not formed between R3 in the main office and R5 in the Branch2 office. What is causing the problem?

- A. There is an area ID mismatch.
- B. There is a PPP authentication issue; a password mismatch.
- C. There is an OSPF hello and dead interval mismatch.
- D. There is a missing network command in the OSPF process on R5.

**Correct Answer:** C

**Section:** (none)

**Explanation**

**Explanation/Reference:**

Explanation:

Here are the relevant parts of the router configs:

```
R1interface Loopback0description ***Loopback***ip address 192.168.1.1 255.255.255.255ip ospf 1 area 0!interface Ethernet0/0description **Connected to R1-LAN**ip address 10.10.110.1 255.255.255.0ip ospf 1 area 0!interface Ethernet0/1description **Connected to L2SW**ip address 10.10.230.1 255.255.255.0ip ospf hello-interval 25ip ospf 1 area 0!router ospf 1log-adjacency-changes
R2!interface Loopback0description **Loopback**ip address 192.168.2.2 255.255.255.255ip ospf 2 area 0!interface Ethernet0/0description **Connected to R2-LAN**ip address 10.10.120.1 255.255.255.0ip ospf 2 area 0!interface Ethernet0/1description **Connected to L2SW**ip address 10.10.230.2 255.255.255.0ip ospf 2 area 0!router ospf 2log-adjacency-changes
R3username R6 password CISCO36!interface Loopback0description **Loopback**ip address 192.168.3.3 255.255.255.255ip ospf 3 area 0!interface Ethernet0/0description **Connected to L2SW**ip address 10.10.230.3 255.255.255.0ip ospf 3 area 0!interface Serial1/0description **Connected to R4-Branch1 office**ip address 10.10.240.1 255.255.255.252encapsulation pppip ospf 3 area 0!interface Serial1/1description **Connected to R5-Branch2 office**ip address 10.10.240.5 255.255.255.252encapsulation pppip ospf hello-interval 50ip ospf 3 area 0!interface Serial1/2description **Connected to R6-Branch3 office**ip address 10.10.240.9 255.255.255.252encapsulation pppip ospf 3 area 0ppp authentication chap!router ospf 3router-id 192.168.3.3!
R4!interface Loopback0description **Loopback**ip address 192.168.4.4 255.255.255.255ip ospf 4 area 2!interface Ethernet0/0ip address 172.16.113.1 255.255.255.0ip ospf 4 area 2!interface Serial1/0description **Connected to R3-Main Branch office**ip address 10.10.240.2 255.255.255.252encapsulation pppip ospf 4 area 2!router ospf 4log-adjacency-changes
R5!interface Loopback0description **Loopback**ip address 192.168.5.5 255.255.255.255ip ospf 5 area 0!interface Ethernet0/0ip address 172.16.114.1 255.255.255.0ip ospf 5 area 0!interface Serial1/0description **Connected to R3-Main Branch office**ip address 10.10.240.6 255.255.255.252encapsulation pppip ospf 5 area 0!router ospf 5log-adjacency-changes
R6username R3 password CISCO36!interface Loopback0description **Loopback**ip address 192.168.6.6 255.255.255.255ip ospf 6 area 0!interface Ethernet0/0ip address 172.16.115.1 255.255.255.0ip ospf 6 area 0!interface Serial1/0description **Connected to R3-Main Branch office**ip address 10.10.240.10 255.255.255.252encapsulation pppip ospf 6 area 0ppp authentication chap!router ospf 6router-id 192.168.3.3!
```

Continue checking their connected interfaces with the “show running-config” command:

```
R3#show running-config<<output omitted>>!interface Serial1/1description **Connected to R5-Branch2 office**ip address 10.10.240.5 255.255.255.252encapsulation pppip ospf hello-interval 50ip ospf 3 area 0!<<output omitted>>
```

```
R5#show running-config<<output omitted>>!interface Serial1/0description **Connected to R3-Main Branch office**ip address 10.10.240.6 255.255.255.252encapsulation pppip ospf 5 area 0!<<output omitted>>
```

The only difference we can see here is the line “ip ospf hello-interval 50” on R3. This command sets the number of seconds R3 waits before sending the next hello packet out this interface. In this case after configuring this command, R3 will send hello packets to R5 every 50 seconds. But the default value of hello-interval is 10 seconds and R5 is using it. Therefore we can think of a hello interval mismatch problem here. You can verify with the “show ip ospf interface <interface>” command on each router.

```
R3#sh ip ospf int s1/1Serial1/1 is up, line protocol is upInternet Address 10.10.240.5/30, Area 0Process ID 3, Router ID 192.168.3.3, Network Type POINT_TO_POINT, Cost: 64Enabled by interface config, including secondary ip addressesTransmit Delay is 1 sec, State POINT_TO_POINT,Timer intervals configured, Hello 50, Dead 200, Wait 200, Retransmit 5oob-resync timeout 200Hello due in 00:00:28Supports Link-local Signaling (LLS)Index 2/2, flood queue length 0Next 0x0(0)/0x0(0)Last flood scan length is 0, maximum is 0Last flood scan time is 0 msec, maximum is 0 msecNeighbor Count is 0, Adjacent neighbor count is 0Suppress hello for 0 neighbor(s)
```

```
R5#sh ip ospf int s1/0Serial1/0 is up, line protocol is upInternet Address 10.10.240.6/30, Area 0Process ID 5, Router ID 10.10.240.6, Network Type POINT_TO_POINT, Cost: 64Enabled by interface config, including secondary ip addressesTransmit Delay is 1 sec, State POINT_TO_POINT,Timer intervals configured, Hello 10, Dead 40, Wait 40, Retransmit 5ob-resync timeout 40Hello due in 00:00:04Supports Link-local Signaling (LLS)Index 1/1, flood queue length 0Next 0x0(0)/0x0(0)Last flood scan length is 0, maximum is 0Last flood scan time is 0 msec, maximum is 0 msecNeighbor Count is 0, Adjacent neighbor count is 0Suppress hello for 0 neighbor(s)
```

So we can see both hello and dead interval are mismatched because the dead interval always four times the value of hello interval, unless you manually configure the dead interval (with the ip ospf dead-interval <seconds> command).

### QUESTION 61

#### Scenario

Refer to the topology. Your company has decided to connect the main office with three other remote branch offices using point-to-point serial links.

You are required to troubleshoot and resolve OSPF neighbor adjacency issues between the main office and the routers located in the remote branch offices.

Use appropriate show commands to troubleshoot the issues and answer all four questions.

#### Instructions

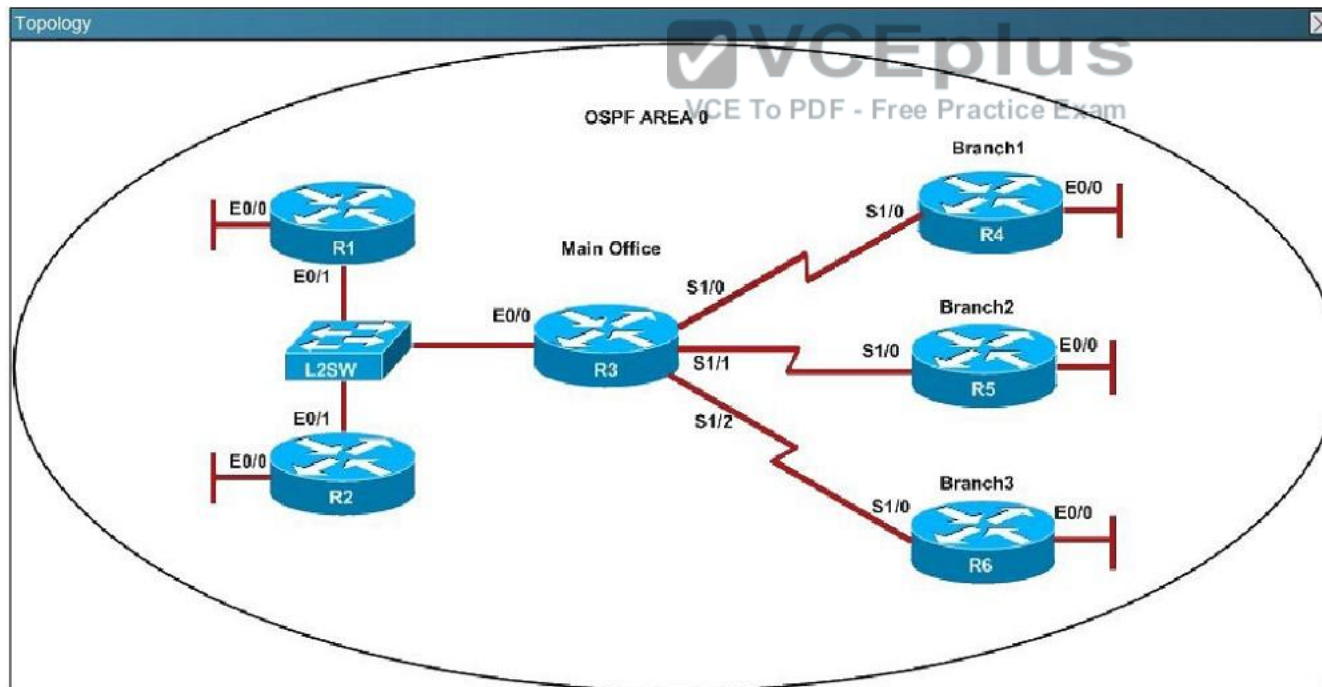

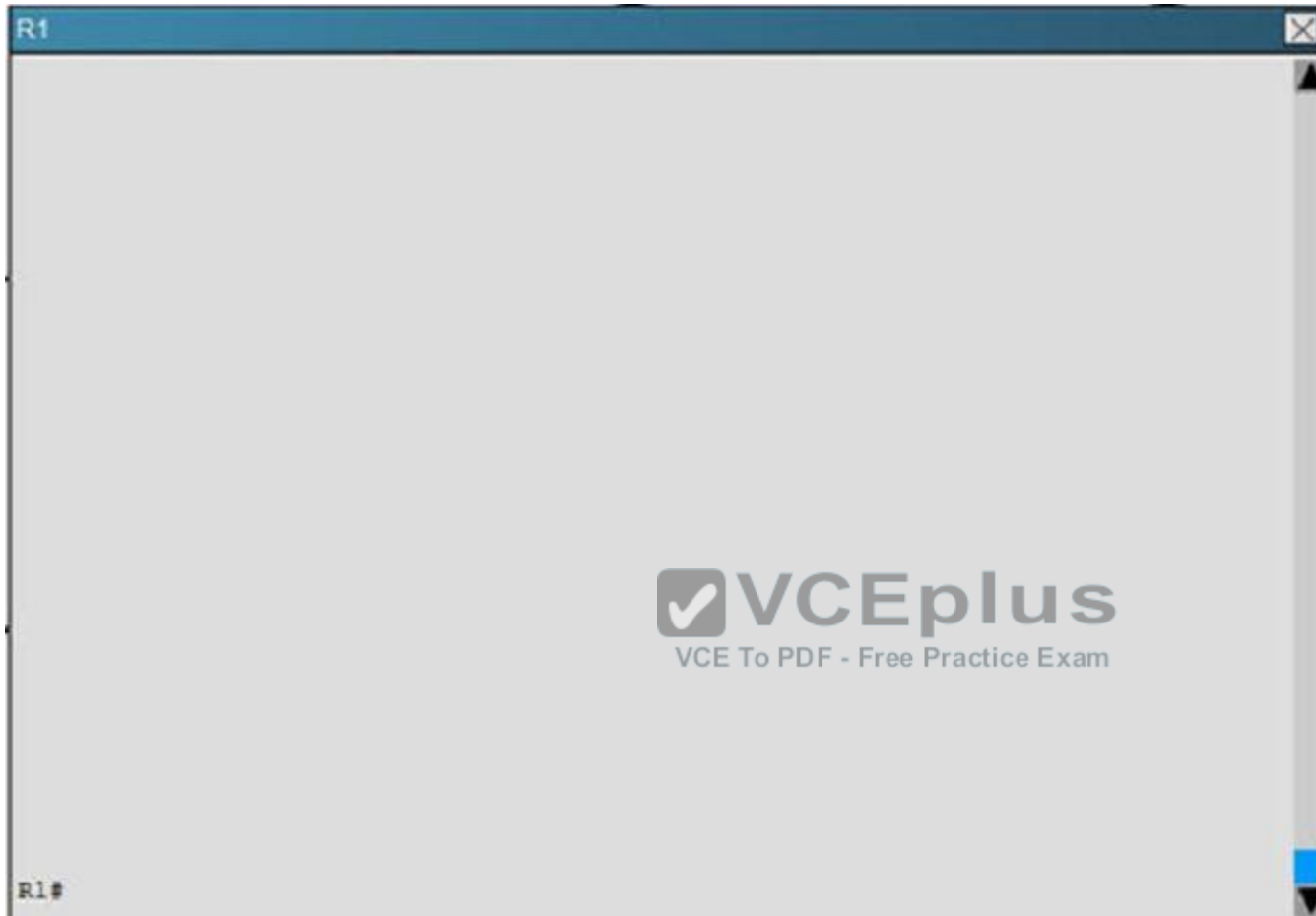

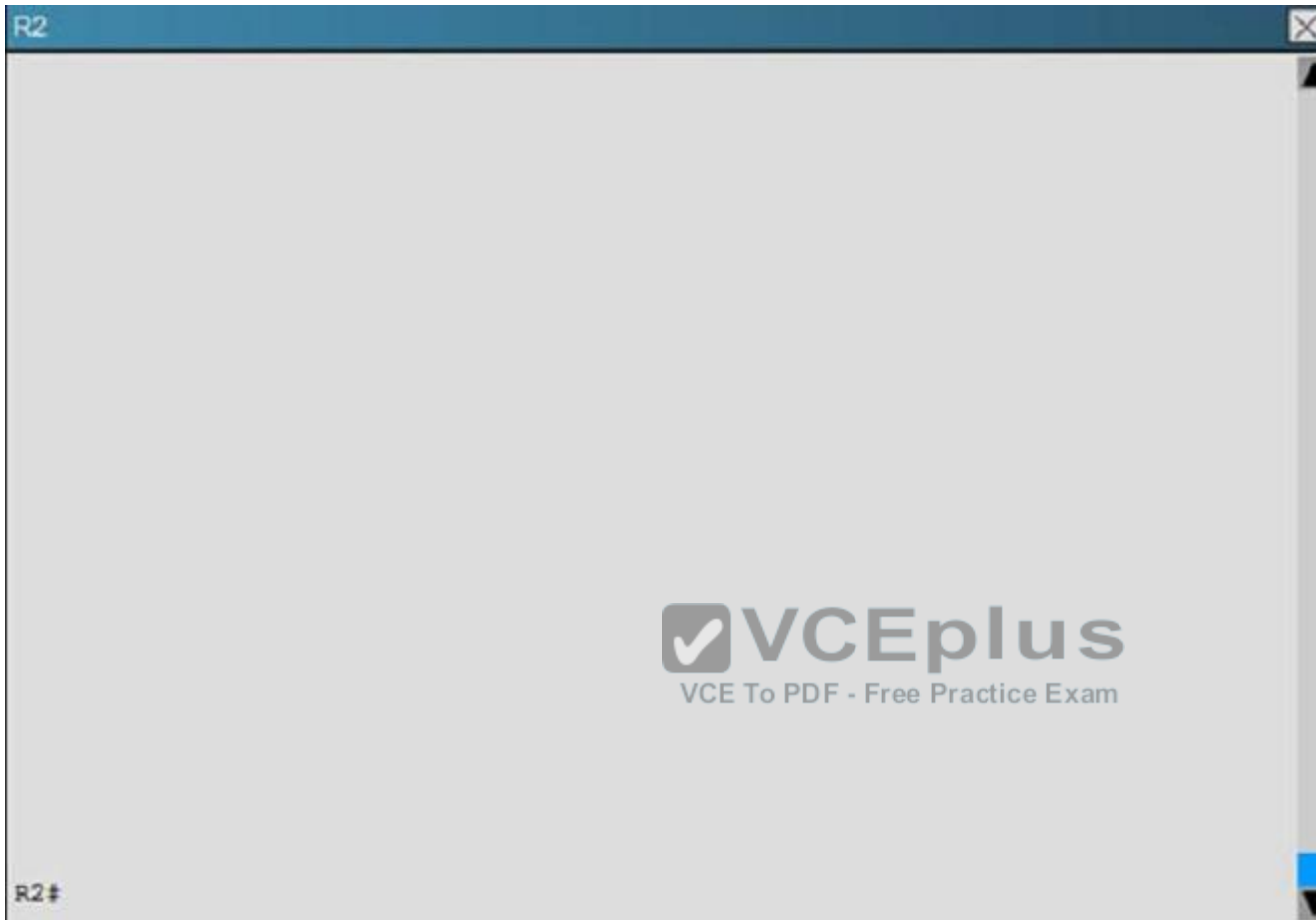



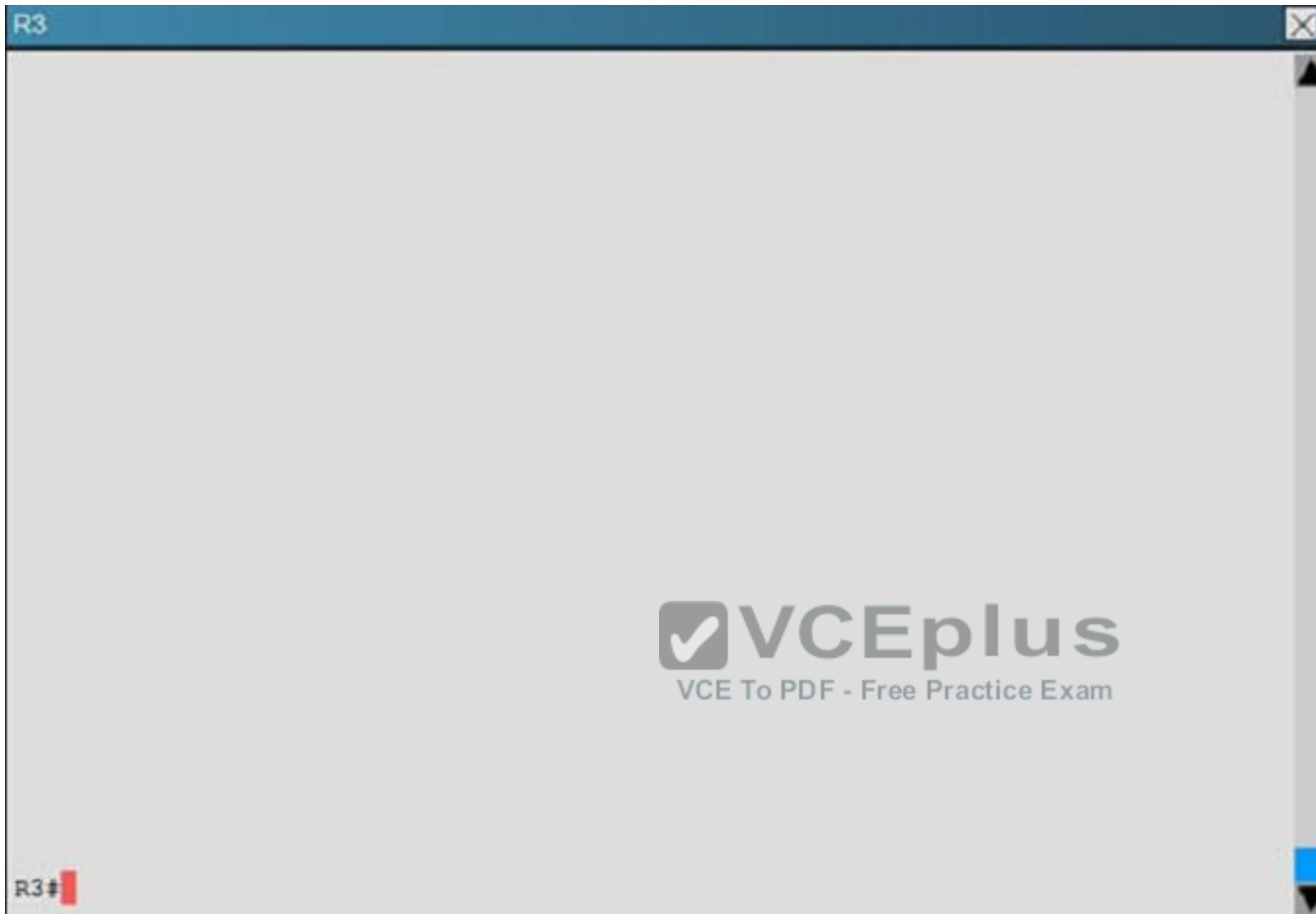

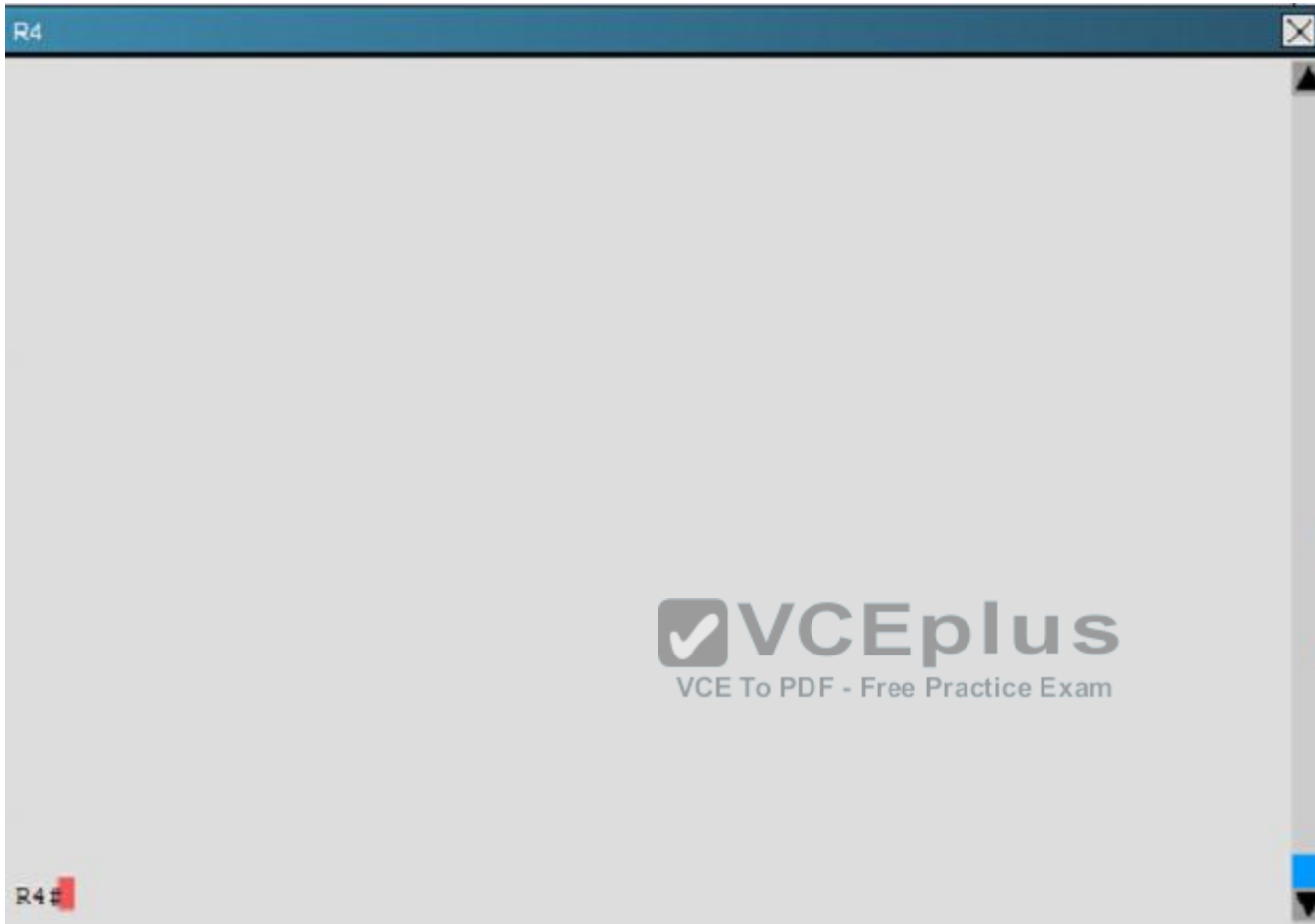

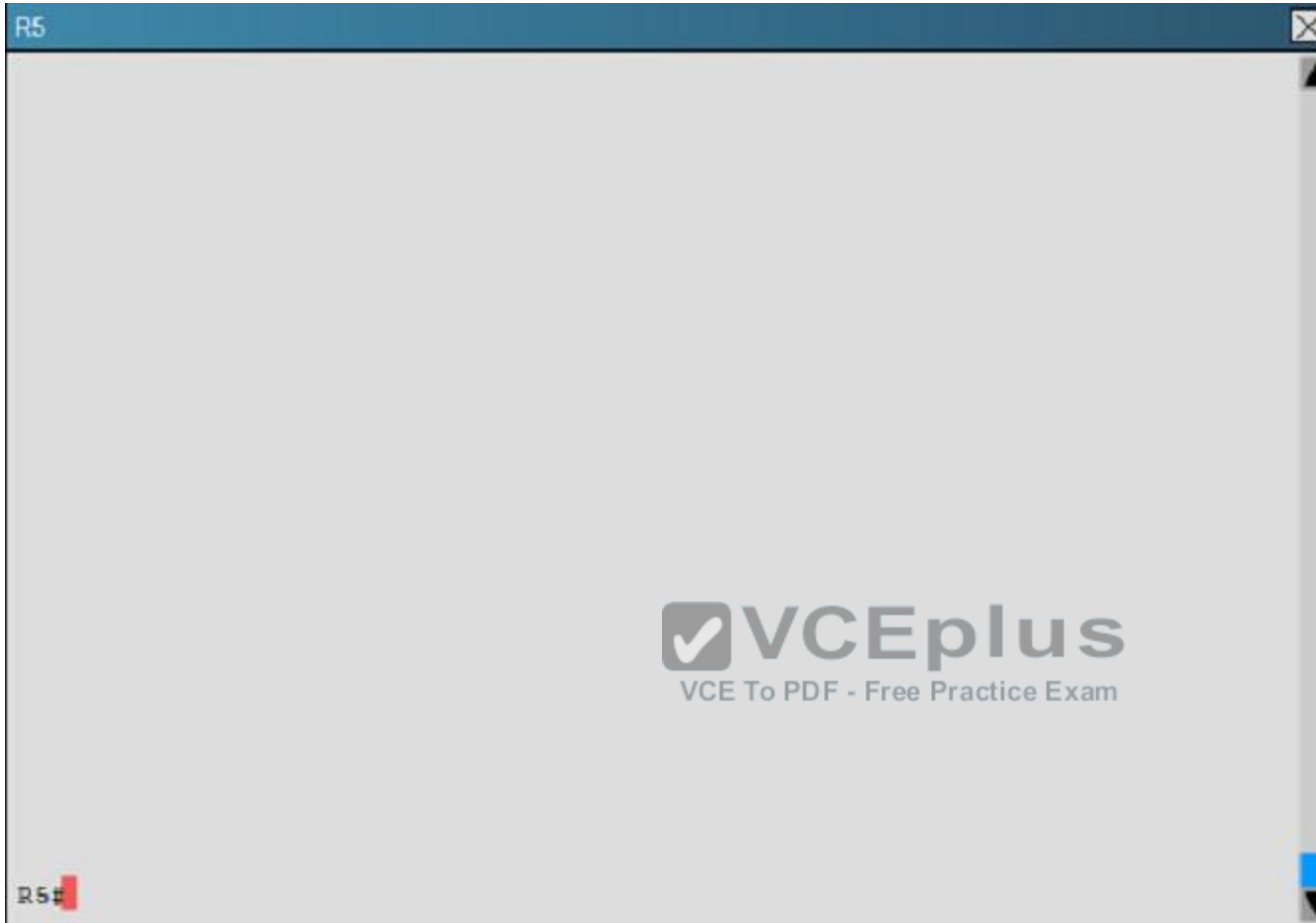



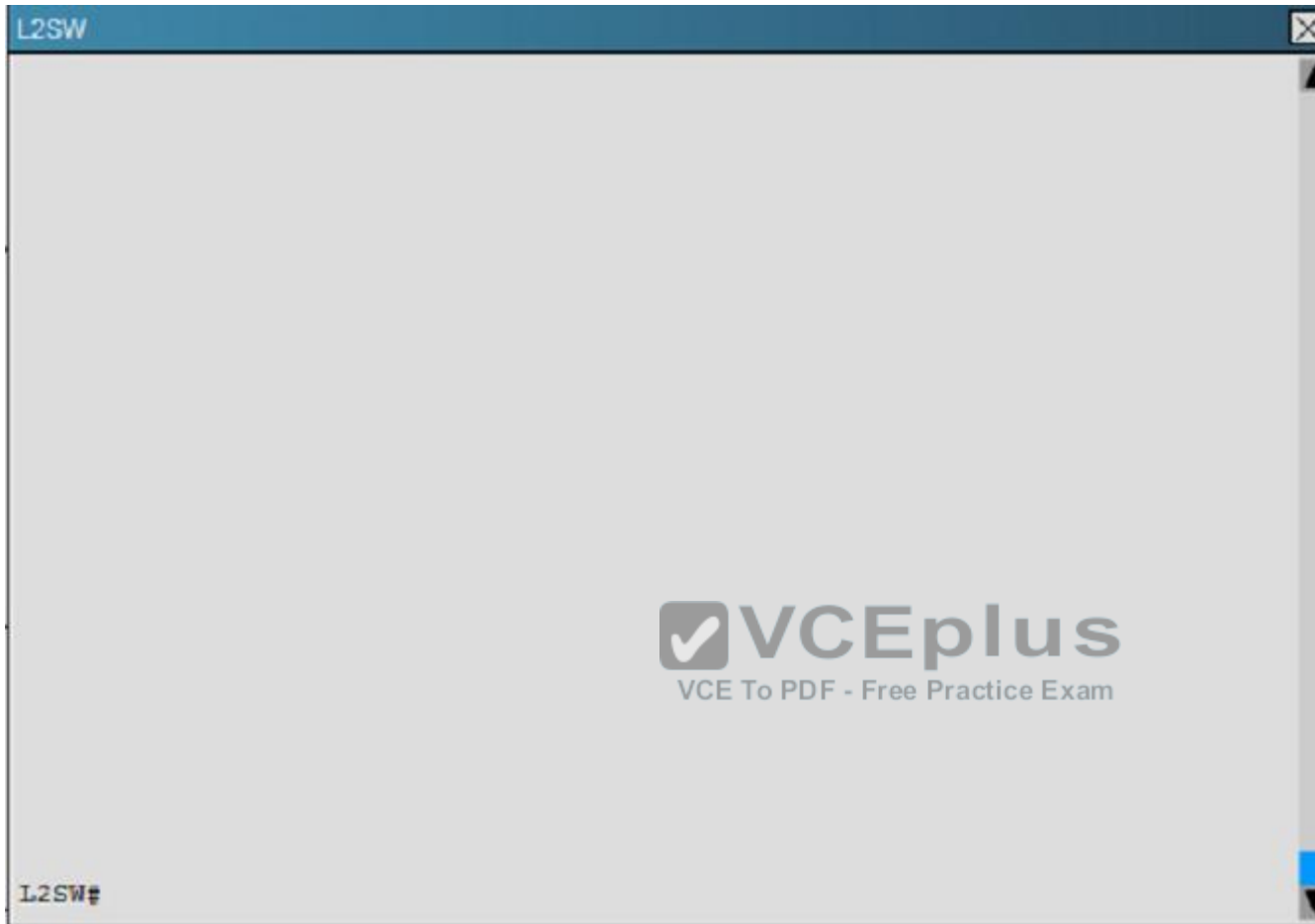

R1 does not form an OSPF neighbor adjacency with R2. Which option would fix the issue?

- A. R1 ethernet0/1 is shutdown. Configure no shutdown command.
- B. R1 ethernet0/1 configured with a non-default OSPF hello interval of 25; configure no ip ospf hello-interval 25
- C. R2 ethernet0/1 and R3 ethernet0/0 are configured with a non-default OSPF hello interval of 25; configure no ip ospf hello-interval 25
- D. Enable OSPF for R1 ethernet0/1; configure ip ospf 1 area 0 command under ethernet0/1.

**Correct Answer:** B

**Section:** (none)

**Explanation**

**Explanation/Reference:**

Explanation:

Here are the relevant parts of the router configs:

```
R1interface Loopback0description ***Loopback***ip address 192.168.1.1 255.255.255.255ip ospf 1 area 0!interface Ethernet0/0description **Connected to R1-LAN**ip address 10.10.110.1 255.255.255.0ip ospf 1 area 0!interface Ethernet0/1description **Connected to L2SW**ip address 10.10.230.1 255.255.255.0ip ospf hello-interval 25ip ospf 1 area 0!router ospf 1log-adjacency-changes
R2!interface Loopback0description **Loopback**ip address 192.168.2.2 255.255.255.255ip ospf 2 area 0!interface Ethernet0/0description **Connected to R2-LAN**ip address 10.10.120.1 255.255.255.0ip ospf 2 area 0!interface Ethernet0/1description **Connected to L2SW**ip address 10.10.230.2 255.255.255.0ip ospf 2 area 0!router ospf 2log-adjacency-changes
R3username R6 password CISCO36!interface Loopback0description **Loopback**ip address 192.168.3.3 255.255.255.255ip ospf 3 area 0!interface Ethernet0/0description **Connected to L2SW**ip address 10.10.230.3 255.255.255.0ip ospf 3 area 0!interface Serial1/0description **Connected to R4-Branch1 office**ip address 10.10.240.1 255.255.255.252encapsulation pppip ospf 3 area 0!interface Serial1/1description **Connected to R5-Branch2 office**ip address 10.10.240.5 255.255.255.252encapsulation pppip ospf hello-interval 50ip ospf 3 area 0!interface Serial1/2description **Connected to R6-Branch3 office**ip address 10.10.240.9 255.255.255.252encapsulation pppip ospf 3 area 0ppp authentication chap!router ospf 3router-id 192.168.3.3!
R4!interface Loopback0description **Loopback**ip address 192.168.4.4 255.255.255.255ip ospf 4 area 2!interface Ethernet0/0ip address 172.16.113.1 255.255.255.0ip ospf 4 area 2!interface Serial1/0description **Connected to R3-Main Branch office**ip address 10.10.240.2 255.255.255.252encapsulation pppip ospf 4 area 2!router ospf 4log-adjacency-changes
R5!interface Loopback0description **Loopback**ip address 192.168.5.5 255.255.255.255ip ospf 5 area 0!interface Ethernet0/0ip address 172.16.114.1 255.255.255.0ip ospf 5 area 0!interface Serial1/0description **Connected to R3-Main Branch office**ip address 10.10.240.6 255.255.255.252encapsulation pppip ospf 5 area 0!router ospf 5log-adjacency-changes
R6username R3 password CISCO36!interface Loopback0description **Loopback**ip address 192.168.6.6 255.255.255.255ip ospf 6 area 0!interface Ethernet0/0ip address 172.16.115.1 255.255.255.0ip ospf 6 area 0!interface Serial1/0description **Connected to R3-Main Branch office**ip address 10.10.240.10 255.255.255.252encapsulation pppip ospf 6 area 0ppp authentication chap!router ospf 6router-id 192.168.3.3!
```

Continue checking their connected interfaces with the “show running-config” command:

```
R1#show running-config<<output omitted>>!interface Ethernet0/1description **Connected to L2SW**ip address 10.10.230.1 255.255.255.0ip ospf hello-interval 25ip ospf 1 area 0!<<output omitted>>
```

```
R2#show running-config<<output omitted>>!interface Ethernet0/1description **Connected to L2SW**ip address 10.10.230.2 255.255.255.0ip ospf 2 area 0!<<output omitted>>
```

We see the hello interval on R1 is not the same as R2 (and you can verify with the “show ip ospf interface <interface> command”) -> There is a hello and dead interval mismatch problem. We should configure “no ip ospf hello-interval 25 on R1.

Note: Maybe there are some versions of this question in the exam. For example there are some reports saying that Ethernet0/1 on R1 is shutdown (and this is the correct choice in the exam). So please be careful checking the config on the routers before choosing the correct answers.

**QUESTION 62**

Scenario

Refer to the topology. Your company has decided to connect the main office with three other remote branch offices using point-to-point serial links.

You are required to troubleshoot and resolve OSPF neighbor adjacency issues between the main office and the routers located in the remote branch

offices.

Use appropriate show commands to troubleshoot the issues and answer all four questions.

Instructions

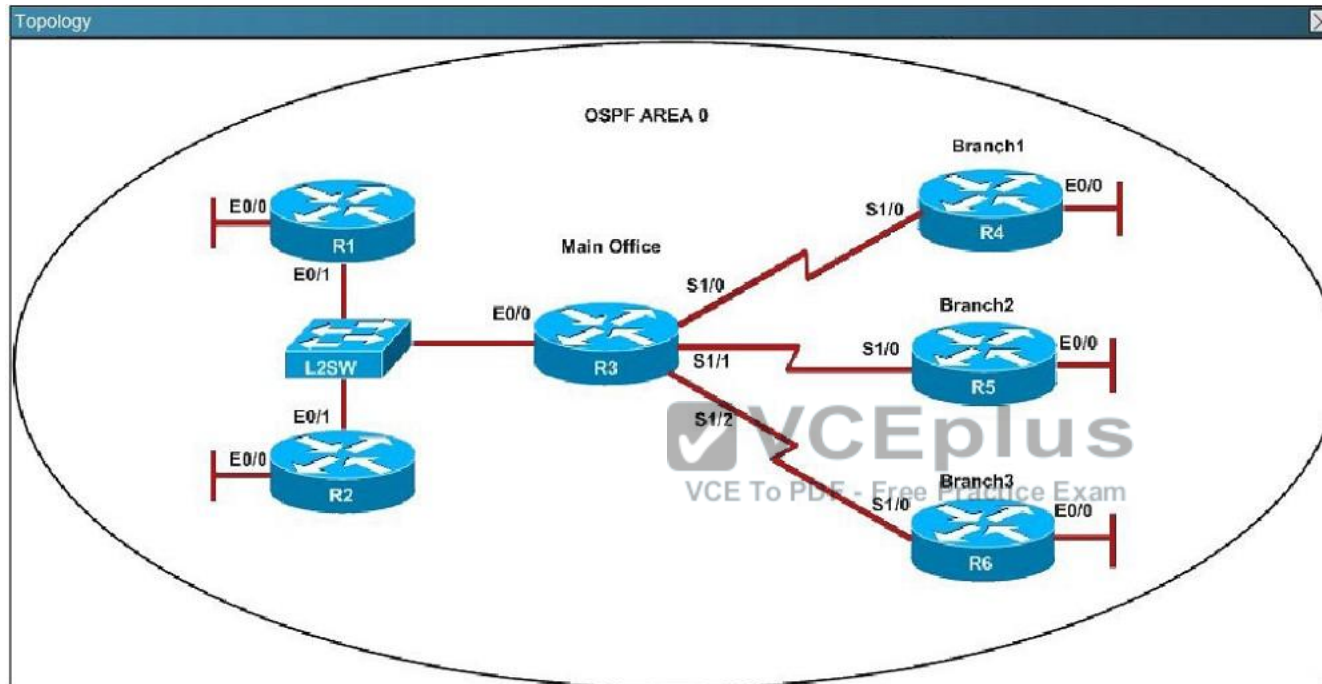

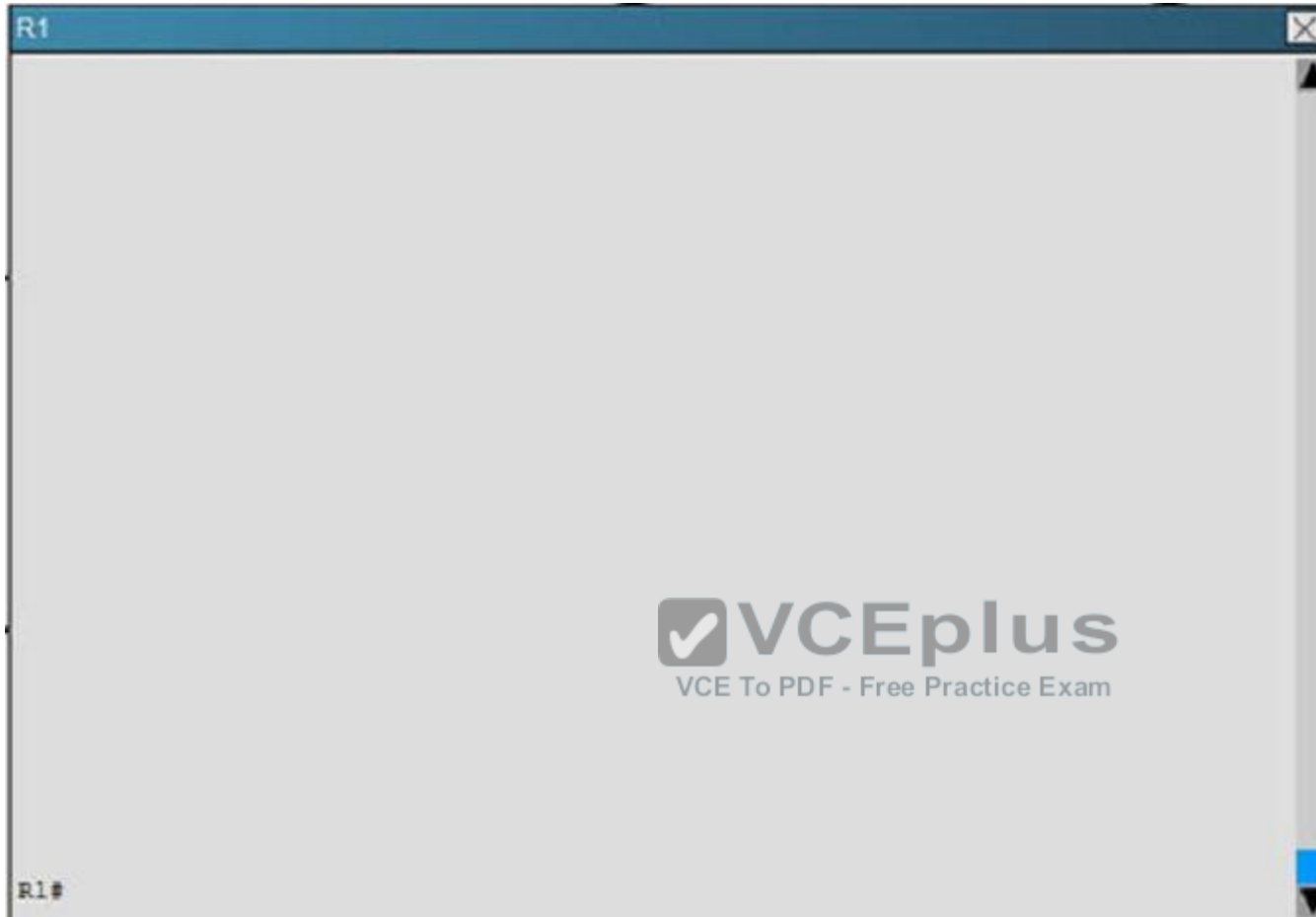



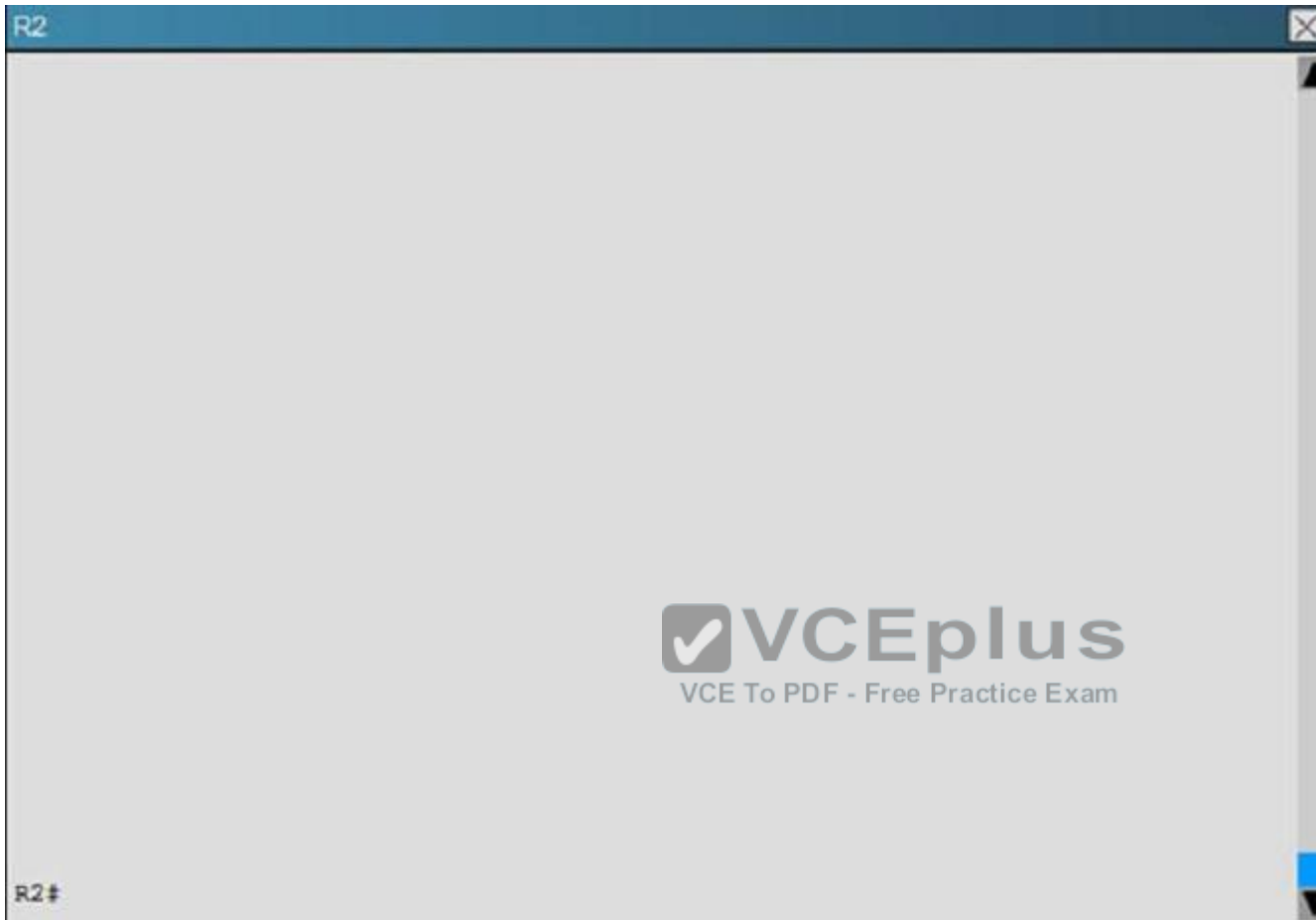

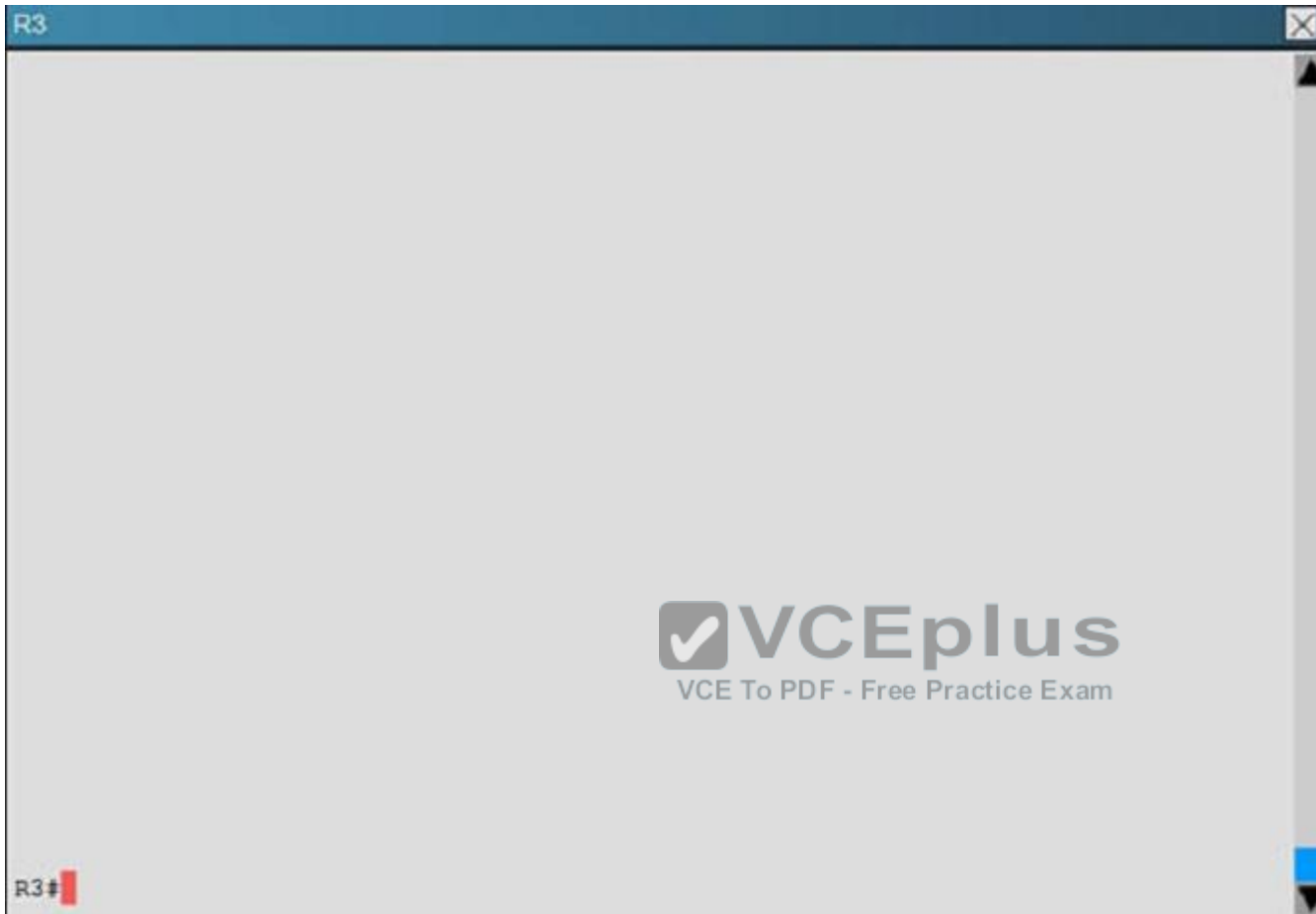

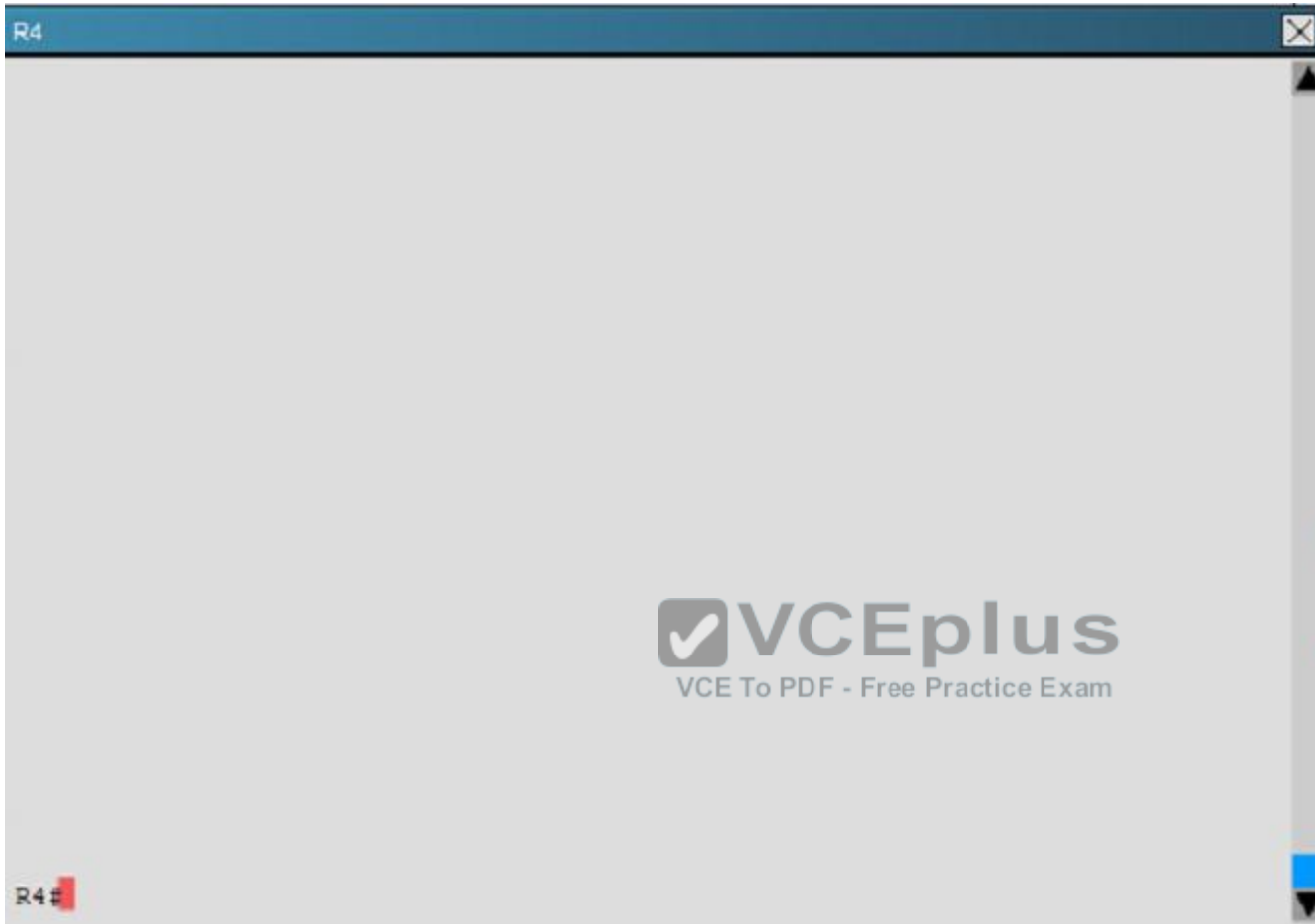

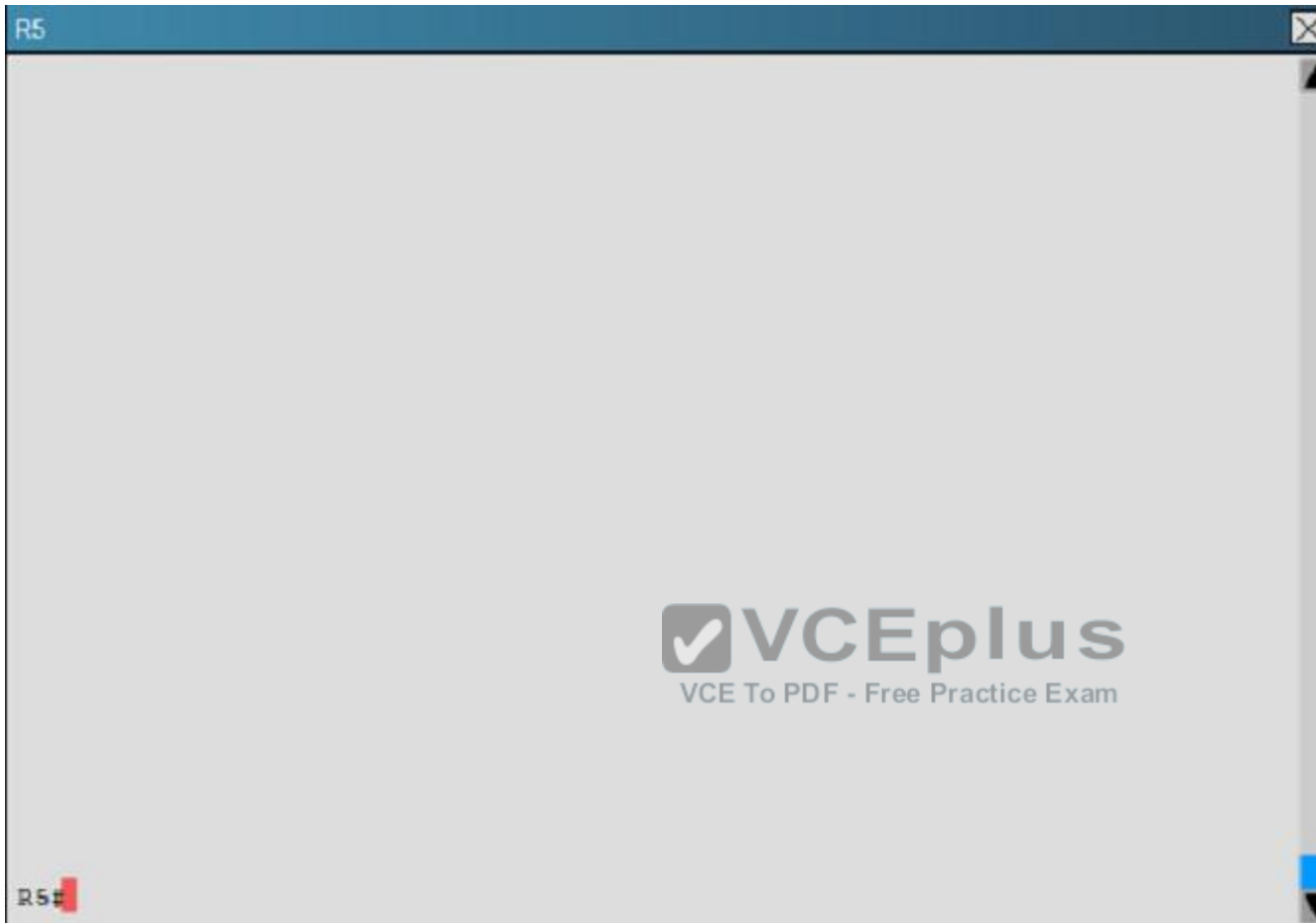



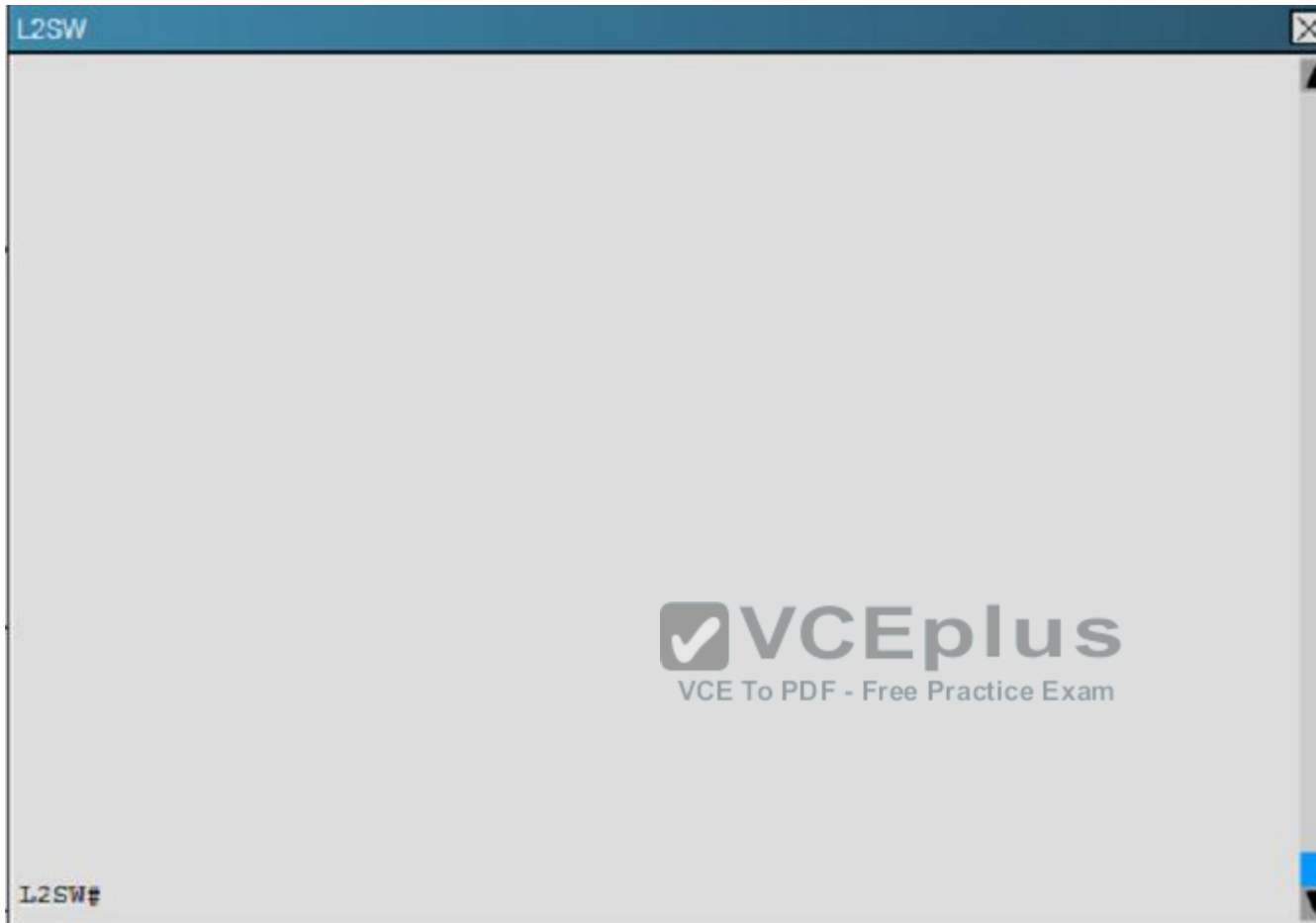

An OSPF neighbor adjacency is not formed between R3 in the main office and R6 in the Branch3 office. What is causing the problem?

- A. There is an area ID mismatch.
- B. There is a PPP authentication issue; the username is not configured on R3 and R6.
- C. There is an OSPF hello and dead interval mismatch.
- D. The R3 router ID is configured on R6.

**Correct Answer:** D

**Section:** (none)

**Explanation**

**Explanation/Reference:**

Explanation:

Here are the relevant parts of the router configs:

```
R1interface Loopback0description ***Loopback***ip address 192.168.1.1 255.255.255.255ip ospf 1 area 0!interface Ethernet0/0description **Connected to R1-LAN**ip address 10.10.110.1 255.255.255.0ip ospf 1 area 0!interface Ethernet0/1description **Connected to L2SW**ip address 10.10.230.1 255.255.255.0ip ospf hello-interval 25ip ospf 1 area 0!router ospf 1log-adjacency-changes
R2!interface Loopback0description **Loopback**ip address 192.168.2.2 255.255.255.255ip ospf 2 area 0!interface Ethernet0/0description **Connected to R2-LAN**ip address 10.10.120.1 255.255.255.0ip ospf 2 area 0!interface Ethernet0/1description **Connected to L2SW**ip address 10.10.230.2 255.255.255.0ip ospf 2 area 0!router ospf 2log-adjacency-changes
R3username R6 password CISCO36!interface Loopback0description **Loopback**ip address 192.168.3.3 255.255.255.255ip ospf 3 area 0!interface Ethernet0/0description **Connected to L2SW**ip address 10.10.230.3 255.255.255.0ip ospf 3 area 0!interface Serial1/0description **Connected to R4-Branch1 office**ip address 10.10.240.1 255.255.255.252encapsulation pppip ospf 3 area 0!interface Serial1/1description **Connected to R5-Branch2 office**ip address 10.10.240.5 255.255.255.252encapsulation pppip ospf hello-interval 50ip ospf 3 area 0!interface Serial1/2description **Connected to R6-Branch3 office**ip address 10.10.240.9 255.255.255.252encapsulation pppip ospf 3 area 0ppp authentication chap!router ospf 3router-id 192.168.3.3!
R4!interface Loopback0description **Loopback**ip address 192.168.4.4 255.255.255.255ip ospf 4 area 2!interface Ethernet0/0ip address 172.16.113.1 255.255.255.0ip ospf 4 area 2!interface Serial1/0description **Connected to R3-Main Branch office**ip address 10.10.240.2 255.255.255.252encapsulation pppip ospf 4 area 2!router ospf 4log-adjacency-changes
R5!interface Loopback0description **Loopback**ip address 192.168.5.5 255.255.255.255ip ospf 5 area 0!interface Ethernet0/0ip address 172.16.114.1 255.255.255.0ip ospf 5 area 0!interface Serial1/0description **Connected to R3-Main Branch office**ip address 10.10.240.6 255.255.255.252encapsulation pppip ospf 5 area 0!router ospf 5log-adjacency-changes
R6username R3 password CISCO36!interface Loopback0description **Loopback**ip address 192.168.6.6 255.255.255.255ip ospf 6 area 0!interface Ethernet0/0ip address 172.16.115.1 255.255.255.0ip ospf 6 area 0!interface Serial1/0description **Connected to R3-Main Branch office**ip address 10.10.240.10 255.255.255.252encapsulation pppip ospf 6 area 0ppp authentication chap!router ospf 6router-id 192.168.3.3!
```

```
R3#show running-config<<output omitted>>username R6 password CISCO36!interface Serial1/2description **Connected to R6-Branch3 office**ip address 10.10.240.9 255.255.255.252encapsulation pppip ospf 3 area 0ppp authentication chap!<<output omitted>>!router ospf 3router-id 192.168.3.3!<<output omitted>>
```

```
R6#show running-config<<output omitted>>username R3 password CISCO36!interface Serial1/0description **Connected to R3-Main Branch office**ip address 10.10.240.10 255.255.255.252encapsulation pppip ospf 6 area 0ppp authentication chap!<<output omitted>>!router ospf 6router-id 192.168.3.3!<<output omitted>>
```

We are not sure about the configuration of ppp authentication in this case. Some reports said that only one router has the “ppp authentication chap” command but it is just a trick and is not the problem here. The real problem here is R6 uses the same router-id of R3 (192.168.3.3) so OSPF neighborhood cannot be established. In real life, such configuration error will be shown in the command line interface (CLI). So please check carefully for this question.